



dBTechnologies

INSTALLATION
2021

PRODUCT INDEX

AEB Industriale s.r.l, founded in 1974 in Bologna, Italy, operates in the Professional Audio market under the brand dBTechnologies and is part of Pro Audio industry leader RCF Group.

AEB Industriale headquarters are located in Bologna where all dBTechnologies products are designed and developed.

Over the years, thanks to a policy of considerable investments in R&D, design and manufacturing technologies, dBTechnologies products have gained substantial recognition for some groundbreaking technological innovations, as well as their inherent standards of quality.

In particular, dBTechnologies has been one of the industry's trailblazer in active speaker & digital amplifier technologies, while giving a major emphasis to details and design.

A constant research on new materials and technologies, together with the ability to create unique design solutions, are the key ingredients for an ever-increasing market share and success.

Now the brand is distributed in more than 160 countries worldwide, providing installation companies, rental companies, sound designers and musicians with audio equipment combining Made in Italy design with top-quality sound performance.

dBTechnologies

IS SERIES

IS4T	Passive Full-range Speaker	05
IS5T	Passive Full-range Speaker	05
IS6T	Passive Coaxial Speaker	05
IS25T	Passive 2-way Speaker	06
IS26T	Passive 2-way Speaker	08
IS8S	Passive Subwoofer	10
IS12S	Passive Subwoofer	10
Examples of installation		12

DVX P SERIES

DVX P8	Passive 2-way Speaker	15
DVX P10	Passive 2-way Speaker	15
DVX P12	Passive 2-way Speaker	15
DVX P15	Passive 2-way Speaker	15
DVX P215	Passive 2-way Speaker	17
DVX PSW15	Passive Subwoofer	18
DVX PSW18	Passive Subwoofer	18
DVX PSW218	Passive Subwoofer	18
Examples of installation		20

LVX P SERIES

LVX P5	Passive Full-range Speaker	22
LVX P8	Passive 2-way Speaker	23
LVX P10	Passive 2-way Speaker	23
LVX P12	Passive 2-way Speaker	23
LVX P15	Passive 2-way Speaker	23
LVX PSW15	Passive Subwoofer	25
LVX PSW18	Passive Subwoofer	25
Examples of installation		26



IS Series

IS4T • IS5T • IS6T

- **PASSIVE FULL-RANGE CUBE SPEAKER - IS4T AND IS5T**
- **PASSIVE 2-WAY COAXIAL CUBE SPEAKER - IS6T**
- **BRACKET INCLUDED**
- **BLACK OR WHITE VERSION AVAILABLE**
- **PHOENIX CONNECTORS**
- **FAST INSTALLATION**
- **FIT-IN-EVERYWHERE DESIGN**



IS4T, IS5T and IS6T are passive cube speakers designed for permanent installations. Simple compact cabinets that fit-in everywhere, essentially designed for high quality background music. IS cube speakers can be installed in a few minutes thanks to the dedicated bracket included in the package. Each single system in IS series comes with a smooth design with few invisible pin points, Phoenix connectors, black or white version.

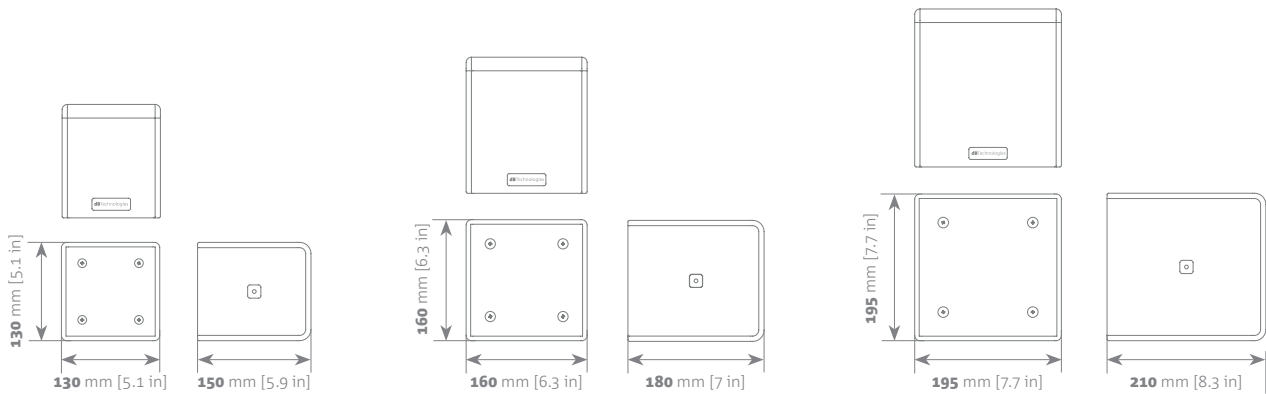

IS4T

IS5T

IS6T

Speaker Type	Passive Full-range Speaker	Passive Full-range Speaker	Passive 2-way Coaxial Speaker
Impedance	8 Ohms	8 Ohms	8 Ohms
Frequency Response [-6 dB]	110 Hz - 20,000 Hz	95 Hz - 18,000 Hz	85 Hz - 20,000 Hz
Sensitivity 1W@1m	89 dB	92 dB	93 dB
Max SPL	111 dB	116 dB	119 dB
Dispersion	110° x 110°	110° x 110°	100° x 100°
HF	-	-	1x 0.75", 1" v.c. Neodymium
LF	1x 4", 1" v.c. full-range woofer	1x 5", 1" v.c. full-range woofer	1x 6.5", 1.5" v.c. Coaxial woofer
Power Handling Capacity (RMS / Peak 10 ms)	40 W / 160 W	60 W / 240 W	100 W / 400 W
Connector Type	Phoenix	Phoenix	Phoenix
Housing	Plywood, water-painted coating	Plywood, water-painted coating	Plywood, water-painted coating
Rigging points	2x M6 threaded nut	2x M6 threaded nut	2x M6 threaded nut
Width	130 mm (5.1 in)	160 mm (6.3 in)	195 mm (7.7 in)
Height	130 mm (5.1 in)	160 mm (6.3 in)	195 mm (7.7 in)
Depth	150 mm (5.9 in)	180 mm (7 in)	210 mm (8.3 in)
Weight	2 kg (4.4 lbs)	2.8 kg (6.17 lbs)	4.8 kg (10.6 lbs)
Accessories	Bracket included	Bracket included	Bracket included

DBTECHNOLOGIES CODE

1030400860 IS4T black
1030400930 IS4TW white

1030400870 IS5T black
1030400940 IS5TW white

1030400880 IS6T black
1030400950 IS6TW white

IS Series

IS25T

- **PASSIVE 2-WAY SPEAKER**
- **100x60° DISPERSION PATTERN**
- **ROTATABLE HORN**
- **VERTICAL OR HORIZONTAL USE**
- **BLACK OR WHITE VERSION AVAILABLE**
- **PHOENIX CONNECTORS**



Speaker Type	2-way passive loudspeaker
Impedance	8 Ohms
Frequency Response [-6 dB]	85 Hz - 20,000 Hz
Sensitivity 1W@m	94.5 dB
Max SPL	121.5 dB
Dispersion	100x60°
HF	1" exit, 1.4" v.c.
LF	2x 5", 1" v.c.
Power Handling Capacity (RMS / Peak 10 ms)	120 W / 480 W
Connector Type	Phoenix
Housing	Plywood, water-painted coating
Rigging points	2x M10 threaded nut (top and bottom)
Width	152 mm (6 in)
Height	485 mm (19 in)
Depth	240 mm (9.4 in)
Weight	7 kg (15.4 lbs)

111 mm [4.37 in]

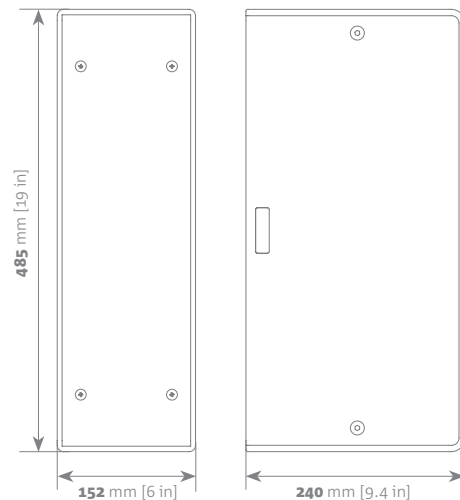
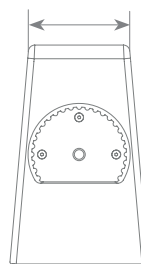

Providing an extremely accurate sound reproduction together with the most precise coverage pattern, IS25T encloses top-notch performances and great versatility in the most compact and sober design.

Thanks to its rotatable horn, users can easily adapt the speaker to vertical or horizontal installation (with the same dedicated accessories available also for VIO X205) providing a constant 60°x100° dispersion pattern.

IS25T is equipped with two times 5" woofers plus a 1" compression driver for the higher end. This box provides a 60 x100° constant dispersion, and you can easily install it either vertically or horizontally using the same accessories of VIO X205. Needless to say the keyword here is: ease of installation and unobtrusiveness. That's why each single system in IS series comes with a smooth design with few invisible pin points, Phoenix connectors, black or white version.



ACCESSORIES

SA-VIOX205

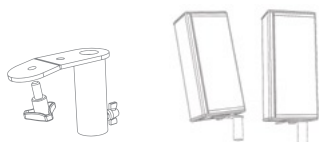

Speaker stand adapter for IS25T.

WB-VIOX205H

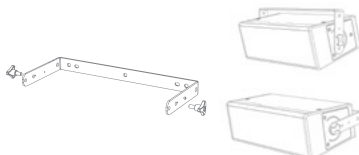

Horizontal wall bracket for IS25T.

WB-VIOX205V

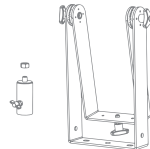

Vertical bracket for IS25T.
36mm pole mount included.

FC-VIOX205



Functional cover for IS25T.

DBTECHNOLOGIES CODE

1030400890 IS25T black, Phoenix
1030400960 IS25TW white, Phoenix

IS Series

IS26T

- **PASSIVE 2-WAY SPEAKER**
- **60x90° ROTATABLE HORN VERSION**
- **100x15° ARRAYABLE VERSION WITH WAVEGUIDE**
- **POINT SOURCE OR LINE ARRAY USE**
- **BLACK OR WHITE VERSION AVAILABLE**
- **PHOENIX CONNECTORS**



Speaker Type	2-way passive loudspeaker
Impedance	8 Ohms
Frequency Response [-6 dB]	85 Hz - 20,000 Hz
Sensitivity 1W@m	94 dB
Max SPL	124 dB
IS26T Dispersion	60x90°
IS26T100 Dispersion	100x15°
HF	1" exit, 1.7" v.c.
LF	2x 6.5", 1.7" v.c.
Power Handling Capacity (RMS / Peak 10 ms)	250 W / 1000 W
Connector Type	Phoenix
Housing	Plywood, water-painted coating
Rigging points	2x M10 threaded nut (top and bottom)
Width	210 mm (8.3 in)
Height	650 mm (25.6 in)
Depth	270 mm (10.6 in)
Weight	15.5 kg (34.17 lbs)

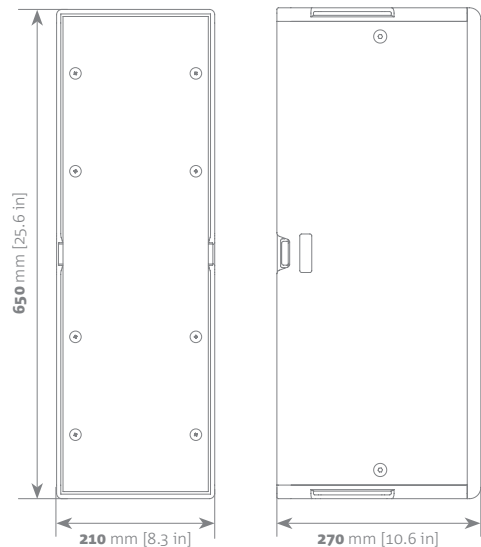
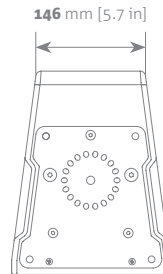

Equipped with a dual 6.5 woofer plus a 1" compression driver, the cabinet is available in 2 models providing different coverage options. IS26T serves as a traditional point source horn-loaded cabinet delivering a constant 60°x90° coverage or 90°x60° thanks to its rotatable horn. The same brackets and accessories available for VIO X206 allow for a smooth wall or truss install, both for single cabinets or multiple side-by-side clusters.



IS26T100 is designed for horizontal use in clusters, thanks to its acoustic design which utilizes a waveguide to deliver a precise coverage angle of 100°x15° and allowing the cabinet to operate in line array mode. Users can easily assemble a IS26T100 arrays with LP-2 link plate. The very same accessories available for VIO X206 (multiple brackets and flybars) allow for easy and reliable truss install operations.



ACCESSORIES

DRK-1



Flybar for IS26T.

DRK-2



Double-hanging flybar for IS26T.

FC-206



Functional cover for VIO IS26T.

HB-2X6



Horizontal bracket for IS26T.

HK-6090



60x90° horn kit for IS26T.

HK-15100HW



100x15° waveguide kit for IS26T.

LP-2



Link plate for IS26T.

LP-3



60°-link plate for IS26T.

SA-2X6



Speaker stand adapter for IS26T.

VB-2X6



Vertical bracket for IS26T.

DBTECHNOLOGIES CODE

1030400900 IS26T black
1030401140 IS26T100 black

1030400970 IS26TW white
1030401150 IS26T100W white

IS Series

IS8S • IS12S

- **PASSIVE SUBWOOFERS**
- **FLYABLE**
- **COMPACT UNOBTRUSIVE DESIGN**
- **BLACK OR WHITE VERSION AVAILABLE**
- **PHOENIX CONNECTORS**



A matching low-end extension to IS25T and IS26T compact full-range speakers allows for countless solutions in PA designing, ranging from simple basic applications up to the most complex requirements of multi-space or multilevel venues.

IS subwoofer series is comprised of 8" and 12" woofer enclosures, both ready to provide a robust low-end reproduction without affecting the venue's overall design and appearance. Both cabinets are also flyable thanks to M8 pickup points.

IS8S

IS12S

	IS8S	IS12S
Speaker Type	passive subwoofer	passive subwoofer
Impedance	8 Ohms	8 Ohms
Frequency Response [-6 dB]	50 Hz - custom LPF	40 Hz - custom LPF
Sensitivity 1W@m	87 dB	97.5 dB
Max SPL	116 dB	127.5 dB
LF	1x 8", 2" v.c.	1x 12", 2.5" v.c.
Power Handling Capacity (RMS / Peak 10 ms)	200 W / 800 W	250 W / 1000 W
Connector Type	Phoenix	Phoenix
Housing	Plywood, water-painted coating	Plywood, water-painted coating
Rigging points	16x M8 pickup point	16x M8 pickup point
Width	230 mm (9.1 in)	335 mm (13.2 in)
Height	470 mm (18.5 in)	624 mm (24.6 in)
Depth	330 mm (13 in)	400 mm (15.7 in)
Weight	10 kg (22 lbs)	15 kg (33 lbs)

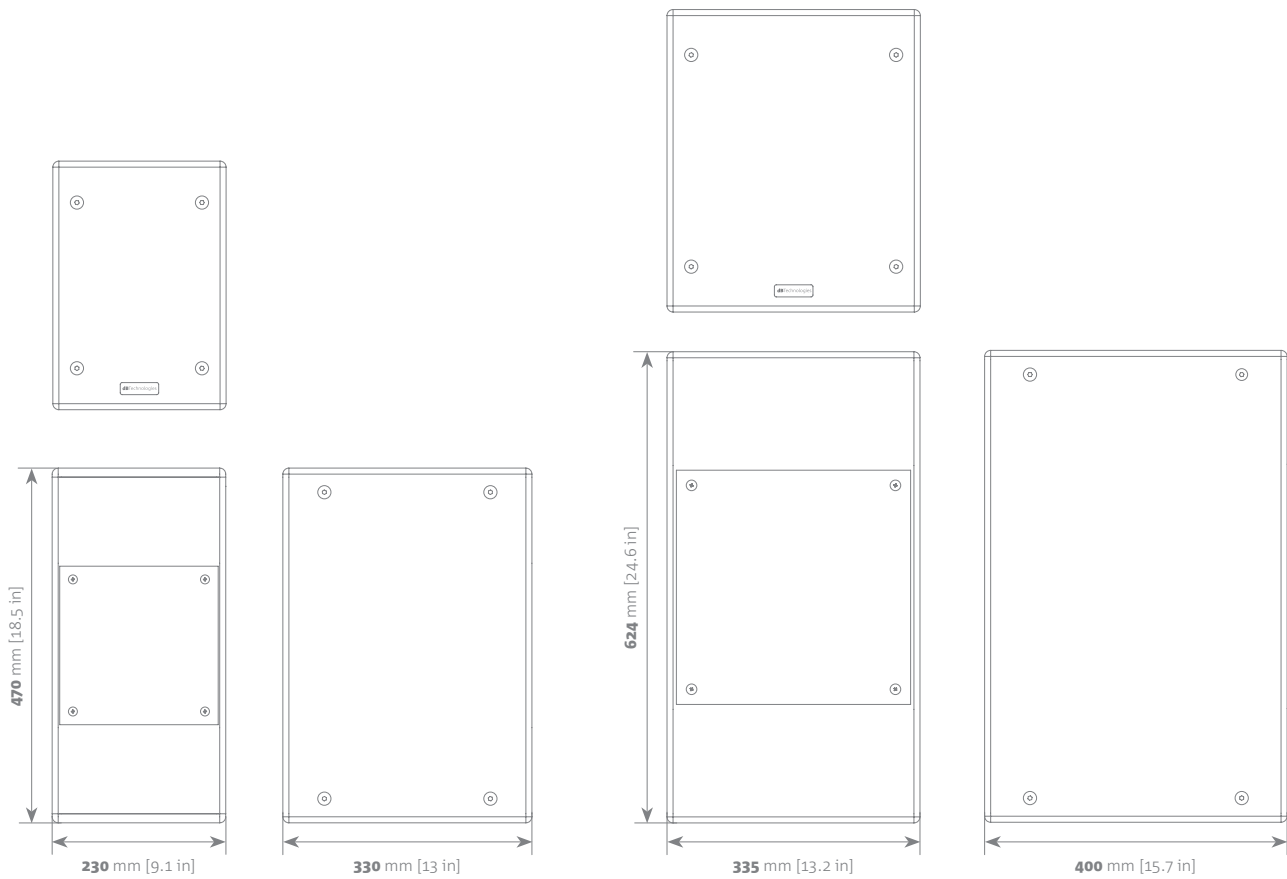

DBTECHNOLOGIES CODE

1030400910 IS8S black

1030400920 IS12S black

1030400980 IS8SW white

1030400990 IS12SW white

11 • IS Series

EXAMPLES OF INSTALLATION

SMALL INSTALLATION: 2.1 SYSTEM (Left + Right + Sub Mono)

Possible applications: conference rooms, schools, small shops

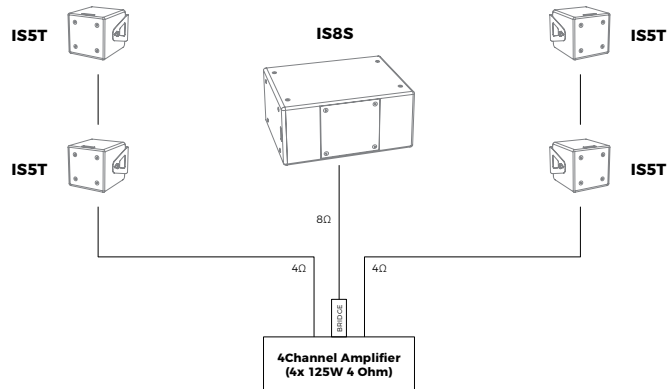

MEDIUM INSTALLATION: SURROUND / IMMERSIVE AUDIO

Possible applications: cinemas, small auditoria, small theaters

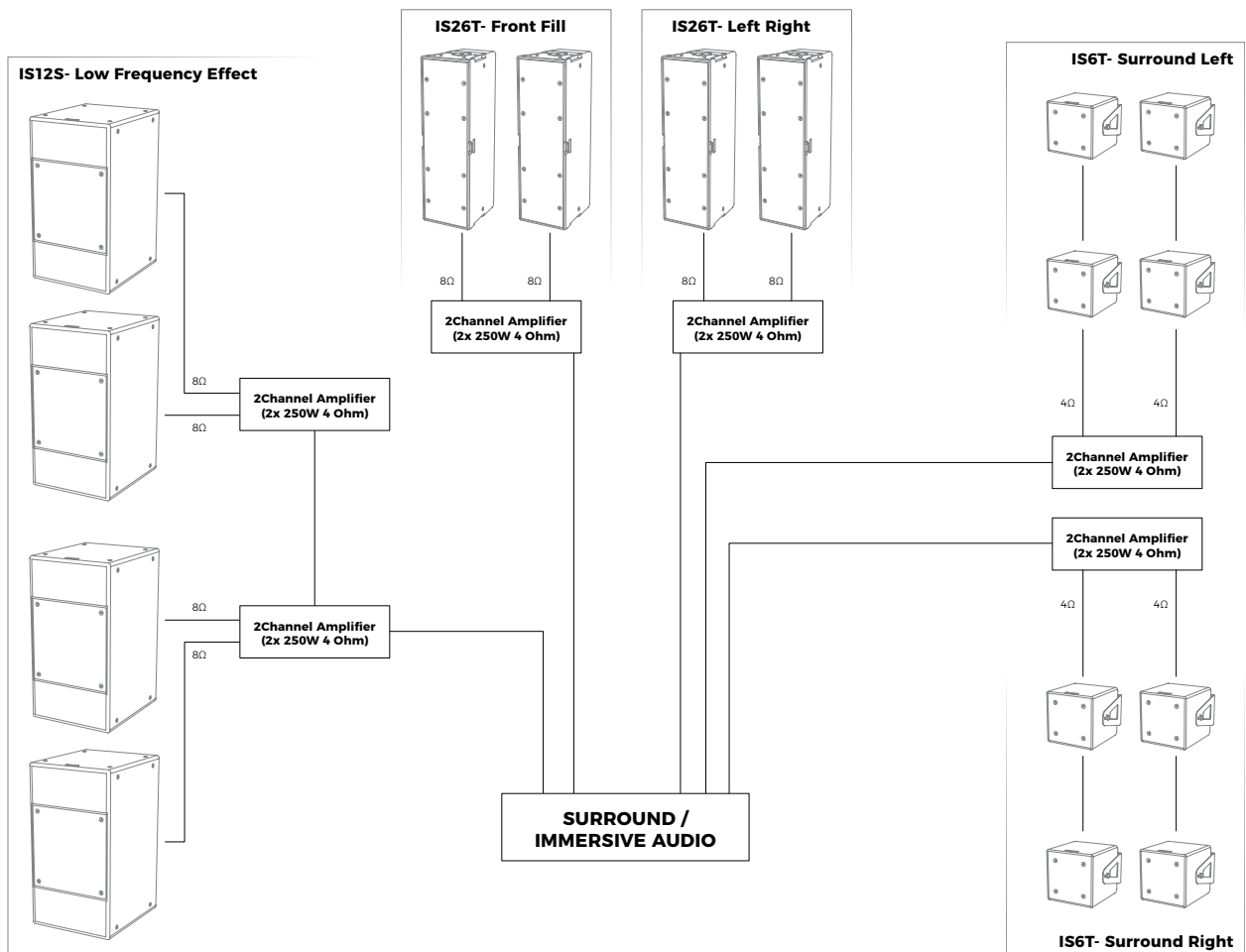

MEDIUM INSTALLATION: HOUSES OF WORSHIP

Possible applications: churches, houses of worship, reverberant rooms

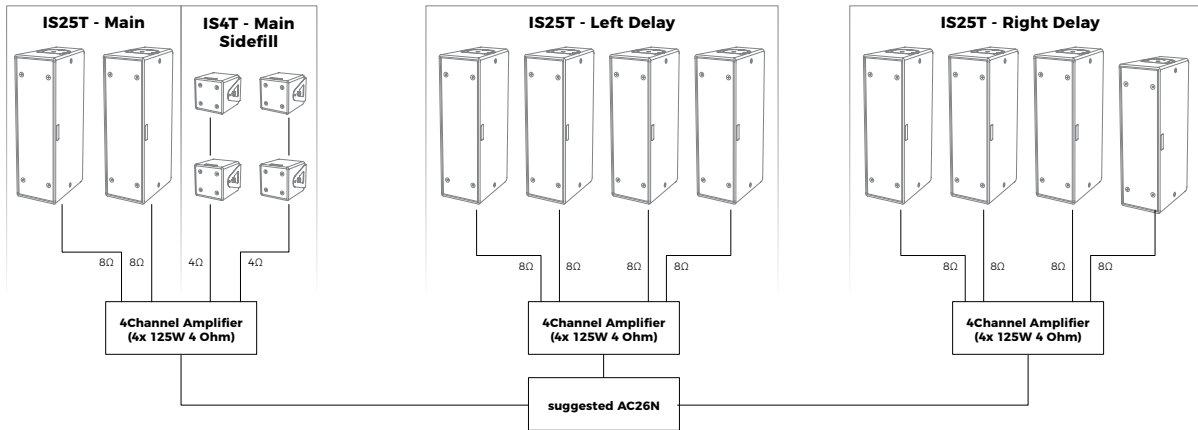

MEDIUM INSTALLATION: AUDITORIA

Possible applications: auditoria, theaters

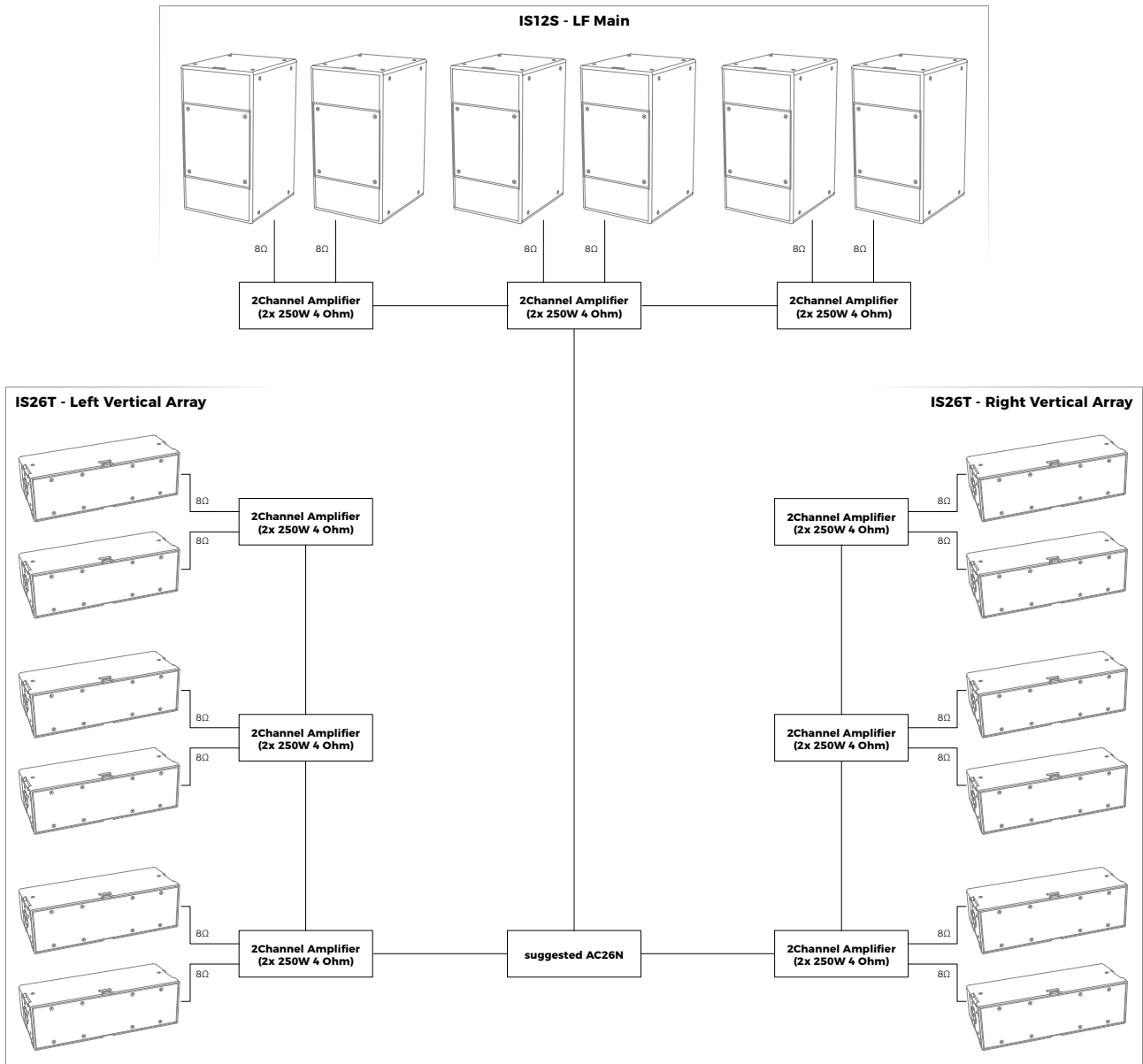



DVX P Series

DVX P8 • DVX P10 DVX P12 • DVX P15

- **MULTIFUNCTION 2-WAY PASSIVE SPEAKERS**
- **ROTATABLE HIGH-FREQUENCY HORNS FOR HORIZONTAL USE**
- **STATE-OF-THE-ART TRANSDUCERS**
- **PREMIUM CROSSOVER WITH PRECISION FILTERS**
- **SELF-RESETTING THERMAL PROTECTION ON HF DRIVER**
- **MULTIPLEX PLYWOOD ENCLOSURES, STURDY AND LIGHTWEIGHT**



Specifically designed to render live or background music, as well as speech contents, in medium to large-sized venues, DVX P passive full-range speaker series encompasses 4 different 2-way systems, ranging from 8" to 15". All cabinets feature high-quality woofers and neodymium compression drivers on symmetric horns. The HF dispersion is 90°x70° on DVX P8 and P10; 90°x40° on DVX P12 and P15; All compression driver horns are rotatable, in order to guarantee the same HF coverage even in case of horizontal or stage monitor use. The transducers are driven by 2-way crossovers with 18dB/oct.

(High-Pass) and 12dB/oct. (Low-Pass) precision filters. The cabinets are reinforced by scratch-resistant black paint, and a rugged metal grille with acoustic foam and are ready for permanent installation thanks to flying pins for quick-release wall-mount brackets and M8/M10 rigging points. All cabinets are provided with a standard aluminum D36mm pole mount cup for sound reinforcement purposes. One single handle on top (for DVX P 8 and DVX P10) or 2 side handles on DVX P12 and DVX P15 ease setup and transportation operations.

	DVX P8	DVX P10	DVX P12	DVX P15
Speaker Type	2-Way Passive Speaker	2-Way Passive Speaker	2-Way Passive Speaker	2-Way Passive Speaker
Impedance	8 Ohms	8 Ohms	8 Ohms	8 Ohms
Frequency Response [-6 dB]	100 Hz - 20,000 Hz	90 Hz - 18,000 Hz	90 Hz - 20,000 Hz	70 Hz - 19,000 Hz
Sensitivity 1W@m	94 dB	96 dB	100 dB	100 dB
Max SPL	125 dB	127 dB	133 dB	133 dB
Dispersion	90° x 70°	90° x 70°	90° x 40°	90° x 40°
Horn	rotatable	rotatable	rotatable	rotatable
HF	1x 1", 1.5" v.c.	1x 1", 1.5" v.c.	1x 1.4", 2.5" v.c.	1x 1.4", 2.5" v.c.
LF	1x 8", 2" v.c.	1x 10", 2" v.c.	1x 12", 3" v.c.	1x 15", 3" v.c.
Power Handling Capacity (RMS / Peak 100 ms)	300 W / 600 W	300 W / 600 W	500 W / 1000 W	500 W / 1000 W
Connector Type	Speakon	Speakon	Speakon	Speakon
Housing	Plywood	Plywood	Plywood	Plywood
Rigging points	12x M8, 2x flypin	12x M8, 2x flypin	12x M10, 4x flypin	12x M10, 4x flypin
Pole Mount	Ø 36 mm	Ø 36 mm	Ø 36 mm	Ø 36 mm
Handles	1 on top	1 on top	1x side	1x side
Width	250 mm (9.84 in)	290 mm (11.4 in)	370 mm (14.6 in)	430 mm (16.9 in)
Height	425 mm (16.73 in)	510 mm (20.10 in)	625 mm (24.6 in)	690 mm (27.2 in)
Depth	260 mm (10.2 in)	310 mm (12.2 in)	395 mm (15.5 in)	450 mm (17.7 in)
Weight	9.8 kg (21.06 lbs.)	12.5 kg (27.6 lbs.)	23.2 kg (51.1 lbs.)	26.1 kg (57.5 lbs.)

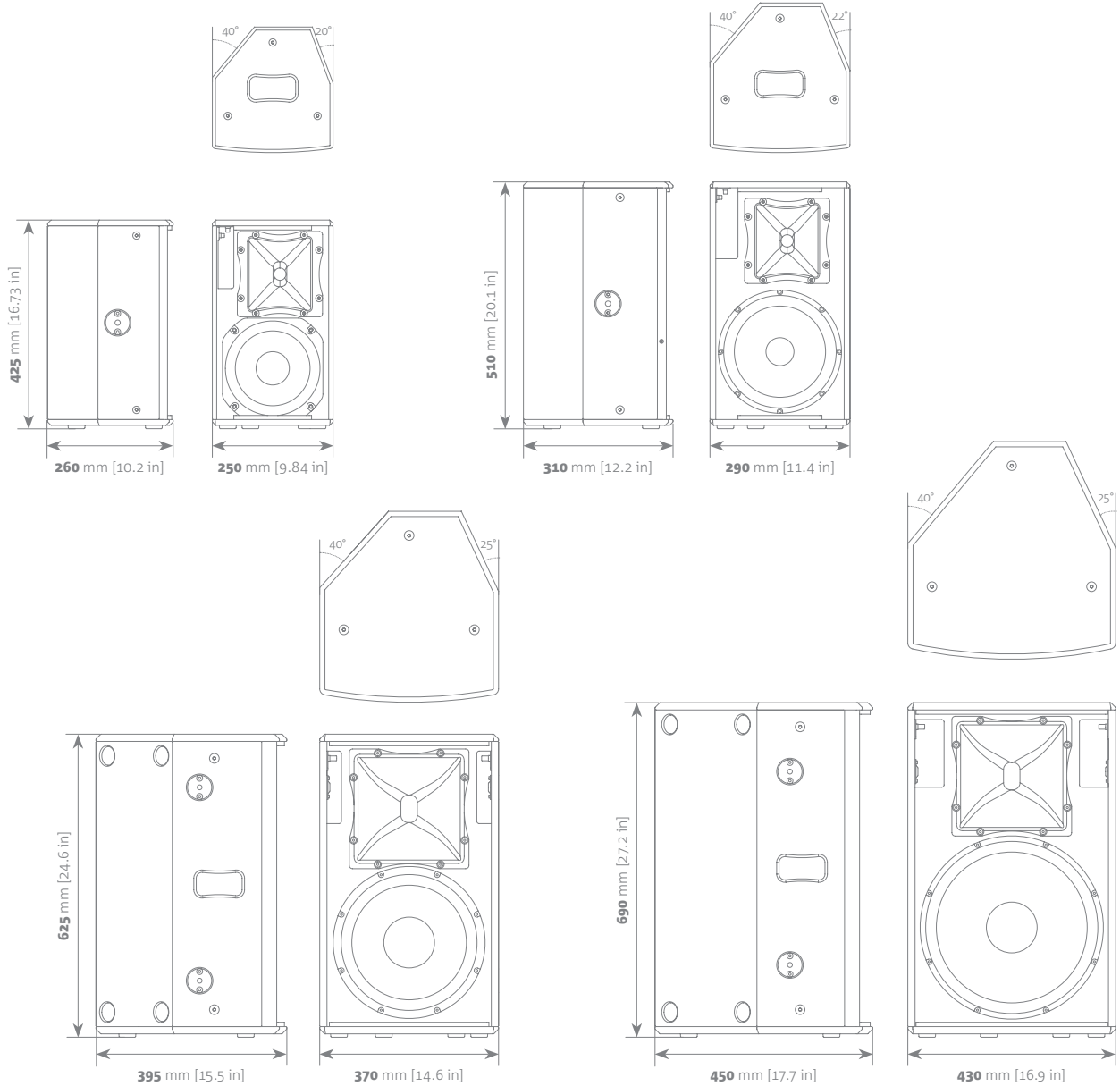

ACCESSORIES

DTF 8



Vertical bracket for DVX P8.

DTF 8A



Vertical bracket for DVX P8.

DTF 10



Vertical bracket for DVX P10.

DTF 10A



Vertical bracket for DVX P10.

DTF 12



Vertical bracket for DVX P12.

DTF 15



Vertical bracket for DVX P15.

TC 8, TC 10, TC 12, TC 15



Transport cover for DVX P8 / P10 / P12 / P15.

TE M8



Eye-bolt set (4 pcs) with M8-thread.

TE M10



Eye-bolt set (4 pcs) with M10-thread.

WB09



Universal wall mount bracket, swivel and tilt Ø35mm pole mount.

DBTECHNOLOGIES CODE

1030400570 DVX P8
1030400580 DVX P10

1030400590 DVX P12
1030400600 DVX P15

DVX P215

- **MULTIFUNCTION 2-WAY PASSIVE SPEAKERS**
- **ROTATABLE HIGH-FREQUENCY HORNS FOR HORIZONTAL USE**
- **STATE-OF-THE-ART TRANSDUCERS**
- **PREMIUM CROSSOVER WITH PRECISION FILTERS**
- **SELF-RESETTING THERMAL PROTECTION ON HF DRIVER**
- **MULTIPLEX PLYWOOD ENCLOSURES, STURDY AND LIGHTWEIGHT**



DVX P215 is a powerful 2-way passive speaker with full-range or bi-amp option, designed to render background or live music in medium to large-sized venues, giving more prominence to the lowest part of the frequency range.

The DVX P215 features two high-quality 15" woofers and a neodymium compression driver on a 60°x40° rotatable CD horn which allows for horizontal use of the cabinet keeping the same coverage pattern. The premium crossover contains precision filters with 12dB/oct. slope for low-pass part and 18dB/oct. for high-pass. All these characteristics assure maximum speech intelligibility and delivers a wormy, assertive bass response without requiring an added subwoofer.

Versatility is enhanced thanks to its 4 handles, the M10 rigging points, and an adjustable foot in the bottom.

DBTECHNOLOGIES CODE

1030400640 DVX P215

Speaker Type	2-Way Passive Speaker
Impedance	4 Ohms
Frequency Response [-6 dB Full-range]	100 Hz - 20,000 Hz
Frequency Response [-6 dB bi-amp]	60 Hz - 2,000 Hz (woofer) 700 Hz - 20,000 Hz (driver)
Sensitivity 1W@1m	103 dB
Max SPL	136 dB
Dispersion	60° x 40°
Horn	rotatable
HF	1x 1.4", 2.5" v.c.
LF	2x 15", 3" v.c.
Power Handling Capacity (RMS / Peak 100 ms)	1000 W / 2000 W
Connector Type	Speakon
Housing	Plywood
Rigging points	11x M10
Pole Mount	Ø 36 mm
Handles	1x side, 1 on top, 1 on bottom
Width	446 mm (17.58 in)
Height	1202 mm (47.32 in)
Depth	500 mm (19.7 in)
Weight	47 kg (103.6 lbs.)

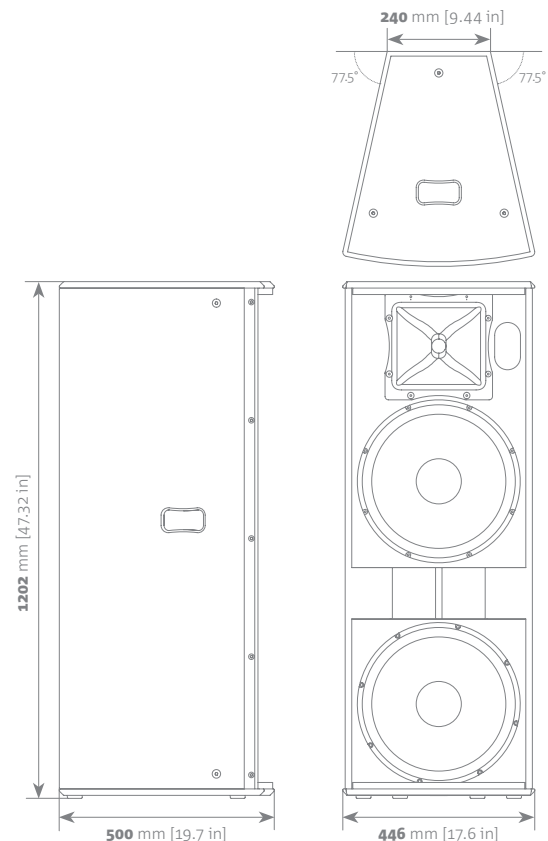

DVX PSW15 • DVX PSW18 DVX PSW218

- **HIGH-PERFORMANCE PASSIVE SUBWOOFERS**
- **STATE-OF-THE-ART TRANSDUCERS**
- **MULTIPLEX PLYWOOD ENCLOSURES, STURDY AND LIGHTWEIGHT**



DVX P series is completed by dedicated DVX PSW subwoofer series encompassing 3 models, respectively equipped with a single 15" a single 18" and double 18" woofers for PSW218. The bass-reflex enclosures with premium transducers enable DVX PSW subs to deliver a truthful impulse response, providing a finely shaped sound image and boosting low-end

frequencies without losing the advantages of portability. All subs are equipped with sturdy handles, standard M20 pole mount plates, wheels predisposition, and recesses on top (side for PSW218) to facilitate stacking of another sub or a full-range speaker.

	DVX PSW15	DVX PSW18	DVX PSW218
Speaker Type	Passive Subwoofer	Passive Subwoofer	Passive Subwoofer
Impedance	8 Ohms	8 Ohms	4 Ohms
Frequency Response [-6 dB]	40 - X-Over Hz	32 - X-Over Hz	32 - X-Over Hz
Max SPL	132 dB	134 dB	140 dB
LF	1x 15", 3" v.c.	1x 18", 4" v.c.	2x 18", 4" v.c.
Power Handling Capacity (RMS / Peak 100 ms)	500 W / 1000 W	1000 W / 2000 W	2000 W / 4000 W
Connector Type	Speakon	Speakon	Speakon
Housing	Plywood	Plywood	Plywood
Pole Mount	M20 (aluminium)	M20 (aluminium)	2x M20 (1 on top and 1 on side)
Handles	1x side	2x side	2x side (top and bottom)
Width	470 mm (18.5 in)	565 mm (22.2 in)	565 mm (22.2 in)
Height	627 mm (24.7 in)	710 mm (27.9 in)	1207 mm (47.5 in)
Depth	600 mm (23.6 in)	700 mm (27.5 in)	700 mm (27.5 in)
Weight	30.9 kg (68.1 lbs.)	44.1 kg (97.2 lbs.)	74.2 kg (163 lbs.)

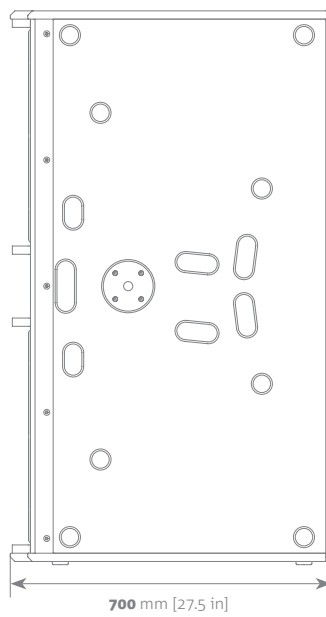
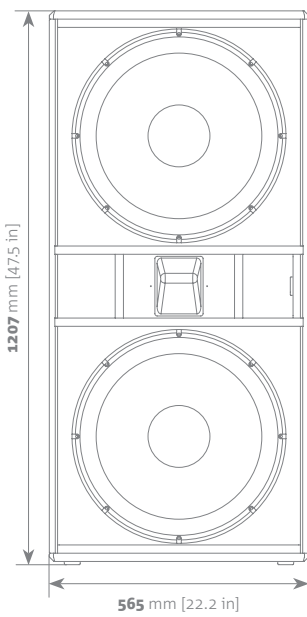
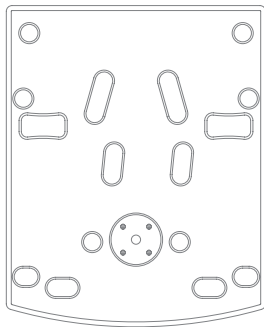
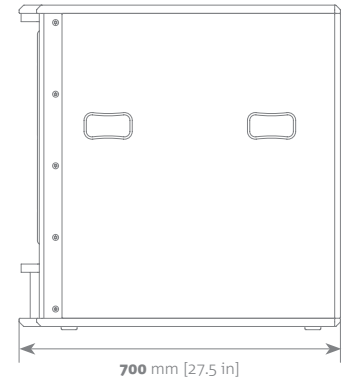
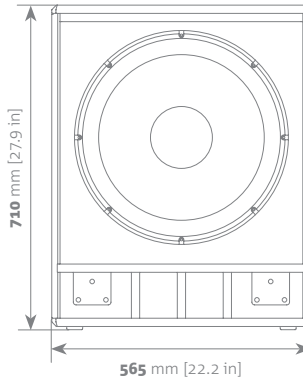
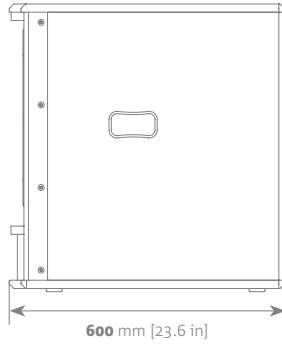
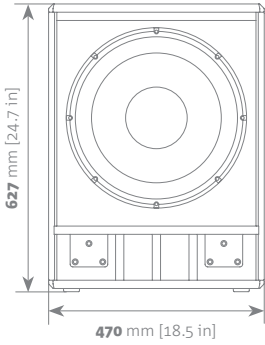
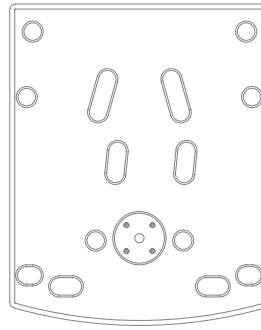
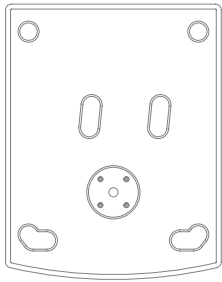

DBTECHNOLOGIES CODE

1030400610 DVX PSW15

1030400620 DVX PSW18

1030400630 DVX PSW218

EXAMPLES OF INSTALLATION

SMALL INSTALLATION

Possible applications: small clubs

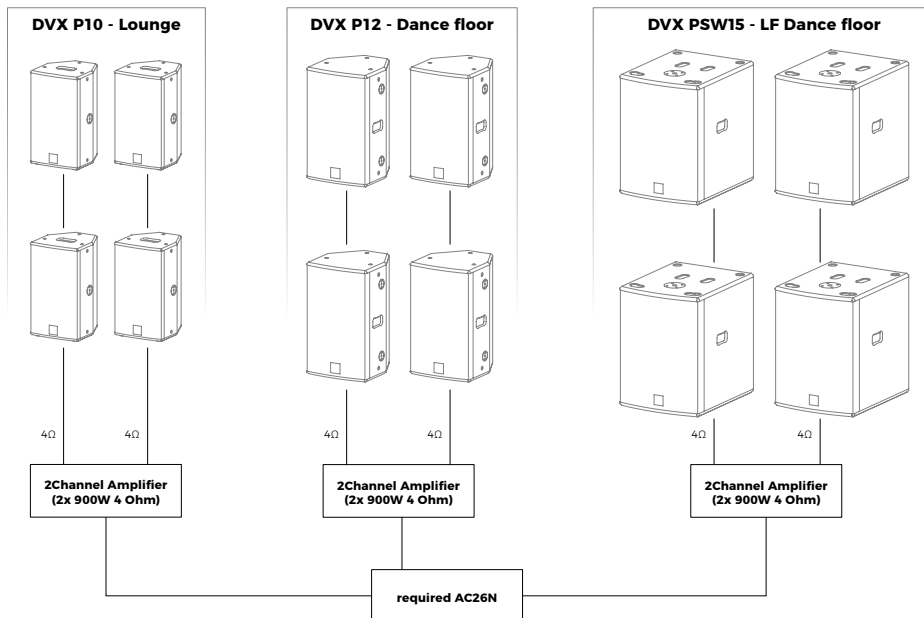

LARGE INSTALLATION

Possible applications: large clubs

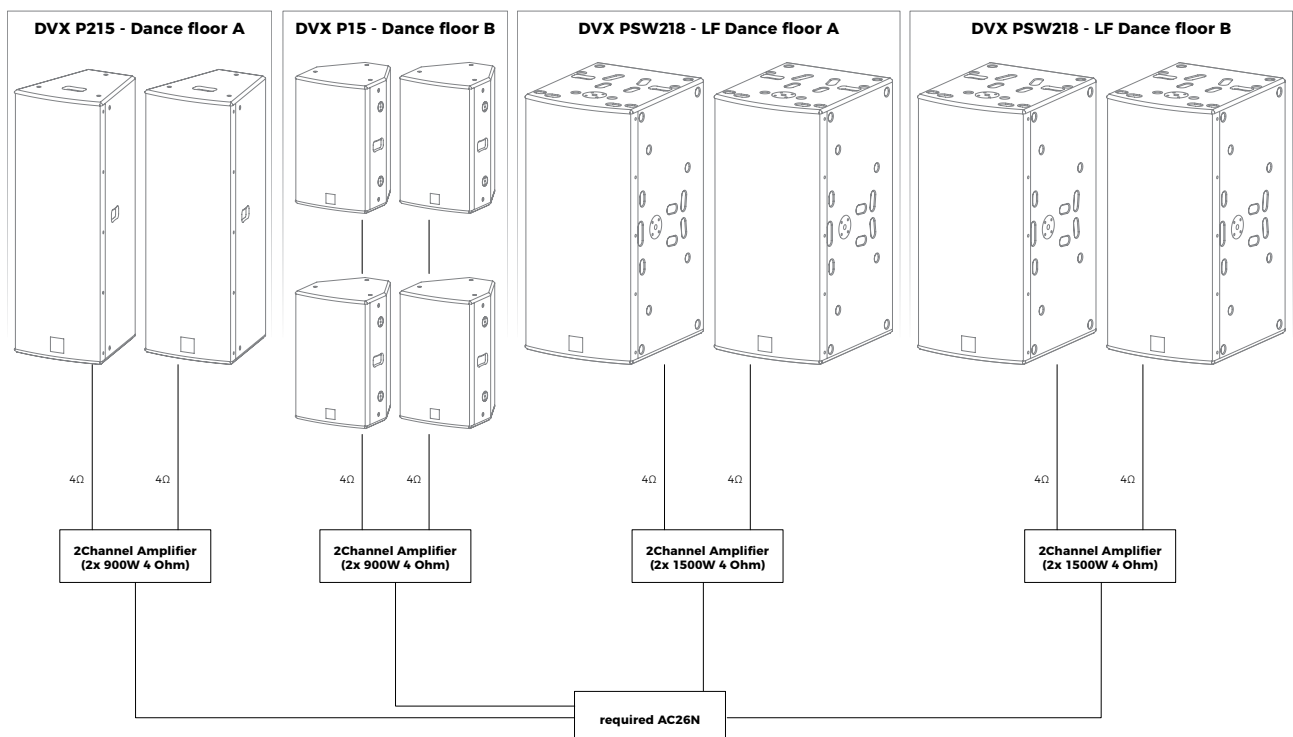



LVX P Series

LVX P5

- **FULL-RANGE PASSIVE SPEAKER**
- **8 OHM OR 16 OHM VERSION AVAILABLE**
- **MAX SPL 115DB**
- **WOODEN LIGHTWEIGHT ENCLOSURE**
- **CLEAN DESIGN**
- **AVAILABLE IN BLACK OR WHITE**
- **BRACKET INCLUDED FOR WALL OR CEILING INSTALLATION**

Speaker Type	Full-range wooden passive loudspeaker
Impedance	8 Ohms or 16 Ohms
Frequency Response [-6 dB]	115 Hz -18,000 Hz
Max SPL	115 dB
Directivity	135x135°
LF	5", 1" v.c.
Power Handling Capacity (RMS / Peak 100 ms)	60 W / 120 W
Connector Type	2-pole Phoenix
Housing	Plywood
Accessories	Wall/ceiling mounting bracket (included)
Width	165 mm (6.49 in)
Height	198 mm (7.79 in)
Depth	175 mm (6.88 in)
Weight	2.2 kg (4.8 lbs)

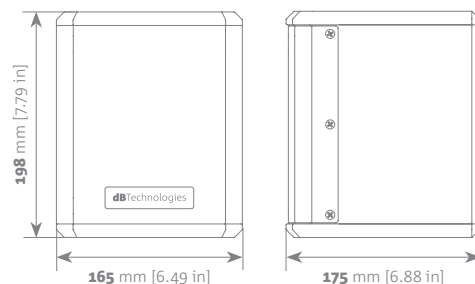
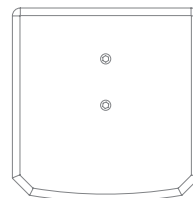

LVX P5 is a passive speaker equipped with a full-range single transducer (5" LF and 1" HF). The most efficient acoustic design, allowing an extended coverage pattern (135°x135°) and a vigorous SPL up to 115 dB, makes this mini full range system the perfect solution to render speech or background music in small venues.

The solid plywood enclosure features a clean, install-friendly design with rigging points on top and side to ease installation on ceiling or wall via the included bracket. LVX P are equipped with Phoenix connectors.

8 or 16 Ohm versions are available for use with dBTechnologies ATI amplifiers. The cabinet comes in black or white, just like all other cabinets in LVX series.

DBTECHNOLOGIES CODE

1030400820 LVX P5 8 Ohm

1030400830 LVX P5 8 Ohm WHITE

1030400840 LVX P5 16 Ohm

1030400850 LVX P5 16 Ohm WHITE

LVX P8 • LVX P10 LVX P12 • LVX P15

- **CLEAN DESIGN**
- **AVAILABLE IN BLACK OR WHITE**
- **ROTATABLE HORN FOR VERTICAL OR HORIZONTAL USE**
- **WOODEN LIGHTWEIGHT ENCLOSURE**



LVX P series line-up is consistent of four 2-way full-range speakers and two bass reflex subwoofers. All cabinets are equipped with premium components and are designed to render speech, live or background music in medium to large venues delivering a clear, detailed audio performance. All the full range speakers provide a 90°x70° (for LVX P8 and 10) or 90°x60° (for LVX P12 and 15) dispersion pattern and are equipped with a rotatable horn to guarantee the same HF coverage even in case of horizontal install. The solid plywood enclosures feature a clean, install-friendly design featuring 12 M8-thread rigging points to ease installation with dedicated vertical (respectively

WB-LP8H, WB-LP10H, WB-LP12H, WB-LP15H) or horizontal brackets (WB-LP810V and WB-LP1215V). All cabinets have integrated handles on sides, but for LVX P8 and P10 that have 1 on back side. All enclosures and accessories are available in black or white version.

	LVX P8	LVX P10	LVX P12	LVX P15
Speaker Type	2-Way Passive Speaker	2-Way Passive Speaker	2-Way Passive Speaker	2-Way Passive Speaker
Impedance	8 Ohms	8 Ohms	8 Ohms	8 Ohms
Frequency Response [- 6dB]	82 - 15,000 Hz	81 - 15,000 Hz	73 - 17,000 Hz	71 - 17,000 Hz
Max SPL	122 dB	125 dB	127 dB	129 dB
HF	1"	1"	1"	1"
Voice Coil HF	1"	1"	1.35"	1.35"
Directivity	90° x 70°	90° x 70°	90° x 60°	90° x 60°
Horn	Rotatable horn	Rotatable horn	Rotatable horn	Rotatable horn
LF	8"	10"	12"	15"
Voice Coil LF	1.5"	1.5"	2"	2.5"
Power Handling Capacity (RMS / Peak 100 ms)	200 W / 400 W	300 W / 600 W	400 W / 800 W	400 W / 800 W
Connector Type	Speakon	Speakon	Speakon	Speakon
Housing	Plywood	Plywood	Plywood	Plywood
Pole mount	Ø 36mm	Ø 36mm	Ø 36mm	Ø 36mm
Angles Up	Monitor use 40°	Monitor use 40°	Monitor use 40°	Monitor use 40°
Rigging Points	12 x M8	12 x M8	12 x M8	12 x M8
Handles	1 on back	1 on back	2 (1x side)	2 (1x side)
Width	255 mm (10.03 in)	300 mm (11.81 in)	360 mm (14.17 in)	420 mm (16.53 in)
Height	426 mm (16.77 in)	496 mm (19.52 in)	610 mm (24 in)	680 mm (26.77 in)
Depth	258 mm (10.15 in)	298 mm (11.73 in)	360 mm (14.17 in)	430 mm (16.92 in)
Weight	8.1 kg (17.8 lbs.)	9.3 kg (20.5 lbs.)	15.1 kg (33.2 lbs.)	19.7 kg (43.4 lbs.)

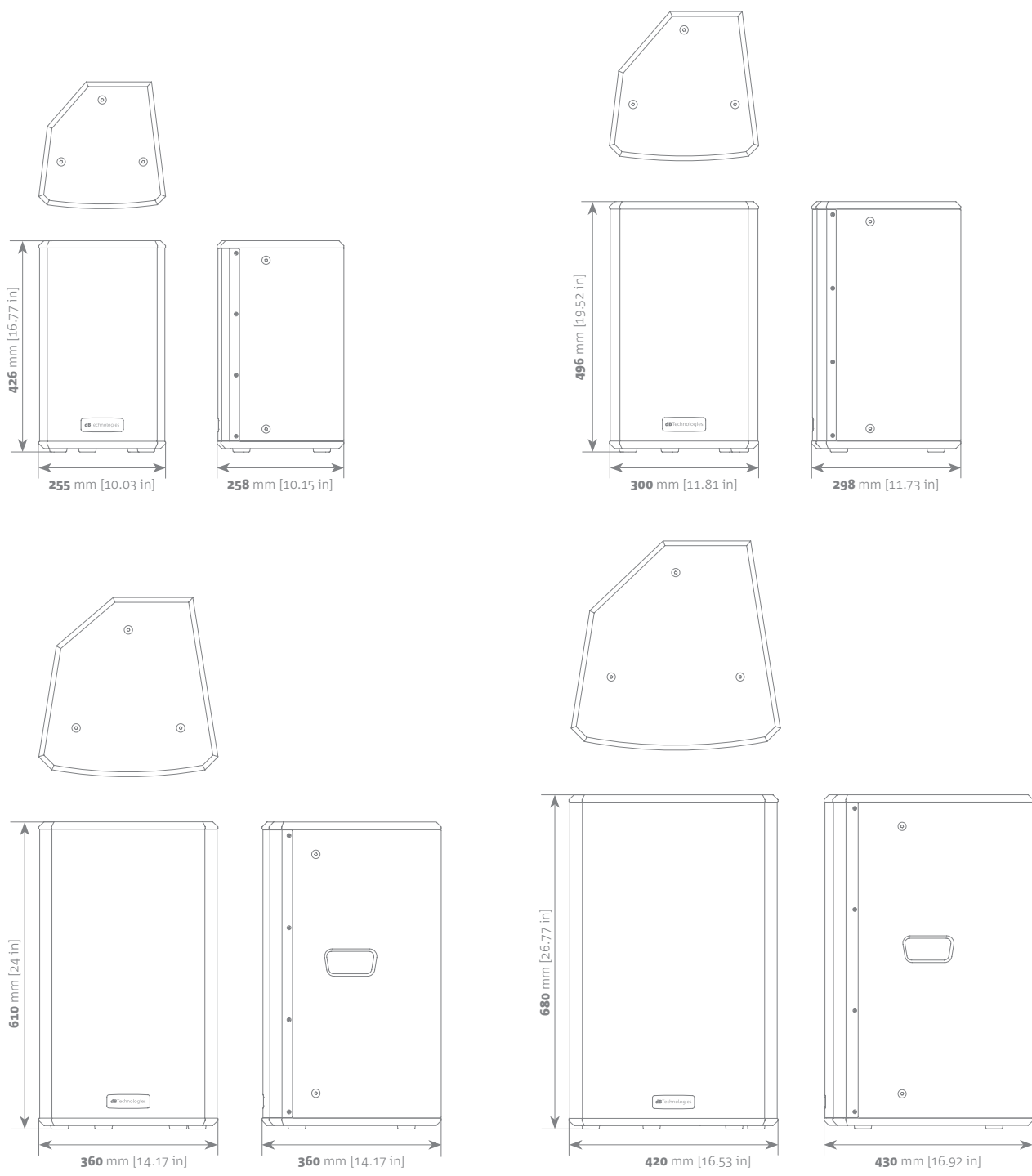

ACCESSORIES

WB-LP8H

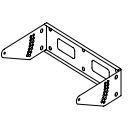

Horizontal bracket for LVX P8. White available

WB-LP10H

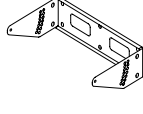

Horizontal bracket for LVX P10. White available

WB-LP12H

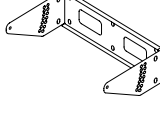

Horizontal bracket for LVX P12. White available

WB-LP15H

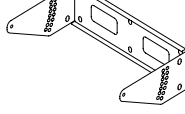

Horizontal bracket for LVX P15. White available

WB-LP810V



Vertical bracket for LVX P8 and P10. White available

WB-LP1215V



Vertical bracket for LVX P12 and P15. White available

DBTECHNOLOGIES CODE

- 1030400700** LVX P8
- 1030400710** LVX P10
- 1030400720** LVX P12
- 1030400730** LVX P15
- 1030400760** LVX P8 white
- 1030400770** LVX P10 white
- 1030400780** LVX P12 white
- 1030400790** LVX P15 white

LVX PSW15 • LVX PSW18

- **PASSIVE SUBWOOFERS**
- **VERTICAL OR HORIZONTAL USE**
- **2x POLE MOUNTS**
- **AVAILABLE IN BLACK OR WHITE VERSION**



LVX P cabinets are equipped with premium components and are designed to render speech, live or background music in medium to large venues delivering a clear, detailed audio performance.

Passive subwoofers LVX PSW15 and LVX PSW18 have been designed to render low end frequencies in medium to large-sized LVX P PA or fixed installations.

The solid plywood enclosures features a clean, install-friendly design featuring 1 integrated handle per side and 2x 36 mm pole mount plates (one on top and one on side), so that the sub can be easily used vertically or horizontally.

All enclosures and accessories of LVX P series are available in black or white version.

LVX PSW15 LVX PSW18

Speaker Type	Passive Subwoofer	Passive Subwoofer
Impedance	8 Ohms	8 Ohms
Frequency Response [-6 dB]	41 - 250 Hz	33 - 250 Hz
Max SPL	130 dB	132 dB
LF	1x 15", 3" v.c.	1x 18", 4" v.c.
Power Handling Capacity (RMS / Peak 100 ms)	500 W / 1000 W	600 W / 1200 W
Connector Type	Speakon	Speakon
Housing	Plywood	Plywood
Pole Mount	2x M20	2x M20
Handles	1x side	2x side
Width	620 mm (24.4 in)	720 mm (28.34 in)
Height	450 mm (17.71 in)	520 mm (20.47 in)
Depth	620 mm (24.4 in)	690 mm (27.16 in)
Weight	26.7 kg (58.8 lbs.)	37 kg (81.5 lbs.)

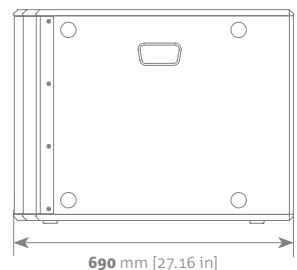
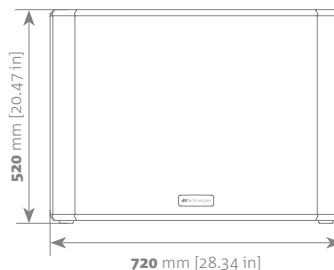
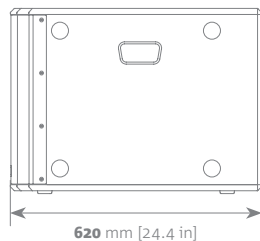
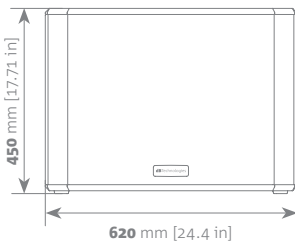
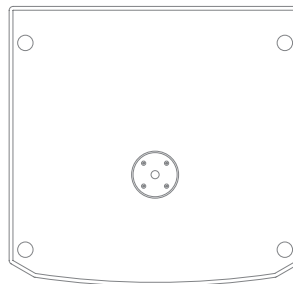
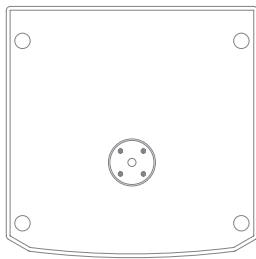

DBTECHNOLOGIES CODE

1030400740 LVX PSW15
1030400750 LVX PSW18

1030400800 LVX PSW15 white
1030400810 LVX PSW18 white

EXAMPLES OF INSTALLATION

MEDIUM INSTALLATION

Possible applications: auditoria, theaters, live clubs, house of worships

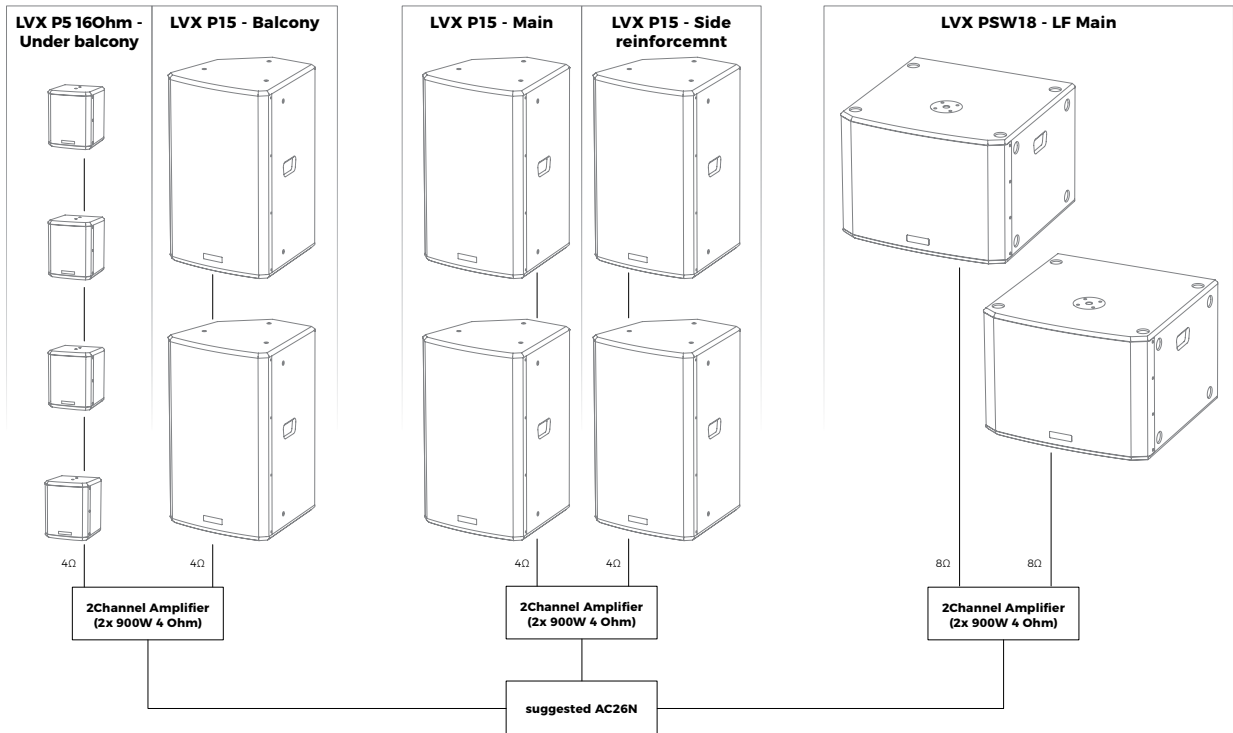

MEDIUM INSTALLATION

Possible applications: medium clubs

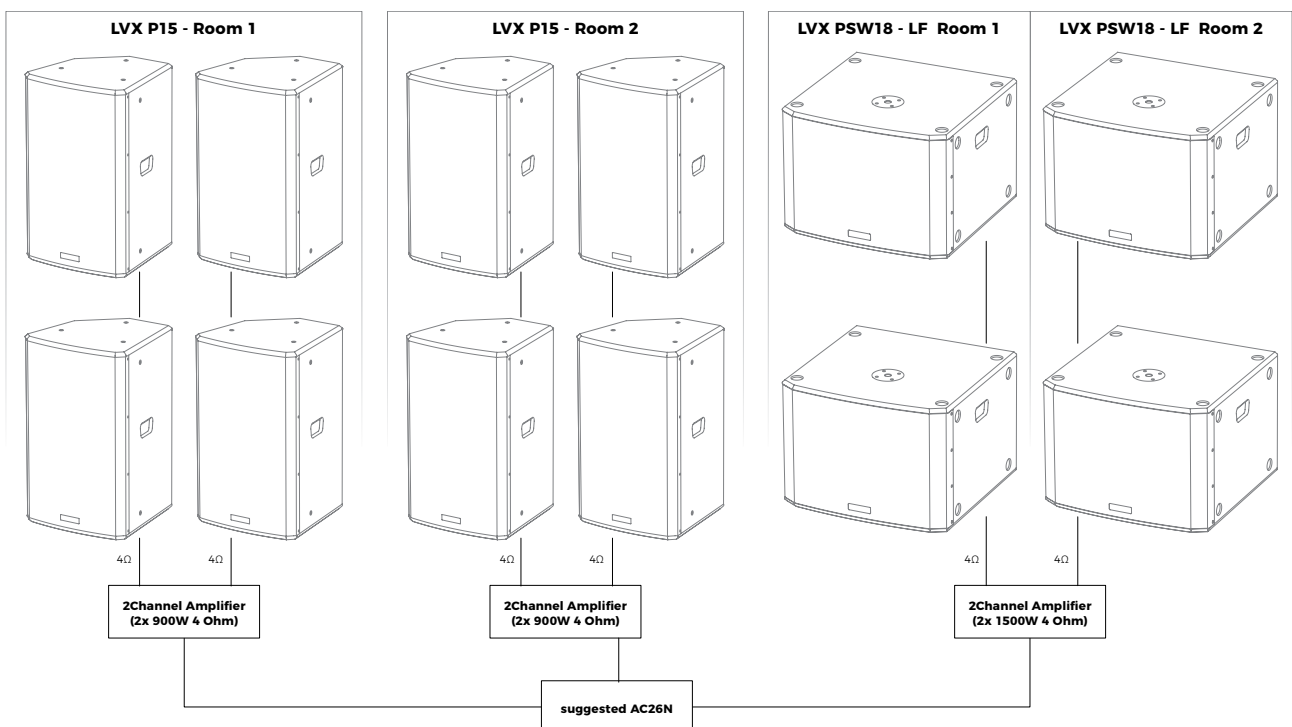

dBTechnologies

Italy & International sales

AEB Industriale Srl

Via Brodolini, 8 - Loc. Crespellano
40053 Valsamoggia (BO) ITALY
Tel +39 051 96 98 70
Fax +39 051 96 97 25

info@dbtechnologies-aeb.com

dBTechnologies Deutschland GmbH

Germany, Belgium, Netherlands, Luxembourg, Austria

Hansestrasse 93
51149 Köln
Tel. +49 (0)2203 925370
Fax. +49 (0)2203 9253773

verkauf@dbtechnologies.de

**dBTechnologies**

www.dbtechnologies.com