



**dB**Technologies

DVA & DVX



AEB Industriale s.r.l. founded in 1974 in Bologna, Italy, operates in the Professional Audio market under the brand dBTechnologies and is part of Pro Audio industry leader RCF Group.

AEB Industriale headquarters are located in Bologna where all dBTechnologies products are designed and developed.

Over the years, thanks to a policy of considerable investments in R&D, design and manufacturing technologies, dBTechnologies products have gained substantial recognition for some groundbreaking technological innovations, as well as their inherent standards of quality.

In particular, dBTechnologies has been one of the industry's trailblazer in active speaker & digital amplifier technologies, while giving a major emphasis to details and design.

A constant research on new materials and technologies, together with the ability to create unique design solutions, are the key ingredients for an ever-increasing market share and success.

In January 2019, the brand was distributed in more than 160 countries worldwide, providing installation companies, rental companies, sound designers and musicians with audio equipment combining Made in Italy design with top-quality sound performance.

**dBTechnologies**

# PRODUCT INDEX

## DVA SERIES

DVA <b>T12</b>	Active Line Array Module	<b>05</b>
DVA <b>T8</b>	Active Line Array Module	<b>09</b>
DVA <b>S30 N</b>	Active Subwoofer	<b>14</b>
DVA <b>S1521 N</b>	Active Subwoofer	<b>15</b>
DVA <b>S1518 N</b>	Active Subwoofer	<b>16</b>
DVA <b>S2585 N</b>	Active Subwoofer	<b>17</b>
DVA <b>S09 DP</b>	Active Subwoofer	<b>18</b>
DVA <b>S08 DP</b>	Active Subwoofer	<b>19</b>
DVA <b>K5</b>	Active Line Array Module	<b>21</b>
DVA <b>KS20</b>	Active Subwoofer	<b>23</b>
DVA <b>KS10</b>	Active Subwoofer	<b>24</b>
DVA <b>MINI G2</b>	Active Line Array Module	<b>25</b>
DVA <b>M2M + M2S</b>	Active Line Array Module	<b>27</b>
DVA <b>MS12</b>	Active Subwoofer	<b>31</b>
DVA <b>Accessories</b>		<b>33</b>

## DVX SERIES

DVX <b>D8 HP</b>	Active Speaker	<b>40</b>
DVX <b>D10 HP</b>	Active Speaker	<b>40</b>
DVX <b>D12 HP</b>	Active Speaker	<b>41</b>
DVX <b>D15 HP</b>	Active Speaker	<b>41</b>
DVX <b>DM12 TH</b>	Active Stage Monitor	<b>42</b>
DVX <b>DM15 TH</b>	Active Stage Monitor	<b>42</b>
DVX <b>DM28</b>	Active Stage Monitor	<b>45</b>
DVX <b>DM12</b>	Active Stage Monitor	<b>46</b>
DVX <b>DM15</b>	Active Stage Monitor	<b>46</b>
DVX <b>Accessories</b>		<b>47</b>



# DIGITAL ARRAY

## SYSTEMS & SUBS

DVA **T12**  
DVA **T8**  
DVA **S30N**  
DVA **S1521N**  
DVA **S1518N**  
DVA **S2585N**  
DVA **S09 DP**  
DVA **S08 DP**  
DVA **K5**  
DVA **KS20**  
DVA **KS10**  
DVA **MINI G2**  
DVA **M2M**  
DVA **M2S**  
DVA **MS12**

- ✦ **FULLY POWERED UNITS, FREELY SCALABLE TO SETUPS OF ANY SIZE**
- ✦ **NONE OF THE IMPEDANCE AND AMP CHANNEL AVAILABILITY CONCERNS ASSOCIATED WITH PASSIVE MODELS**
- ✦ **LOSSLESS SIGNAL PATH WITH NO NEED FOR SPEAKER CABLES**
- ✦ **EXTREMELY TOUGH YET REMARKABLY LIGHT ENCLOSURES**
- ✦ **DIGITAL CONTROLLER (DSP) ON-BOARD FOR UTMOST OPERATING SAFETY**

Line array technology has revolutionized sound reinforcement, particularly for large venues and events. Arraying several speaker cabinets vertically is a far more effective method of delivering and directing sound. Line array's signal levels do not drop off as steeply with increasing distance as is the case with conventional systems. What's more, their patterns of throw are very wide despite the systems' lean configurations. Until recently this technology saw limited use mainly in large, elaborate, and costly projects and installations. But with arrival of DVA, true line array technology is now available for a wide range of portable and permanent sound reinforcement applications.

Factoring all the many different

parameters and users' needs into the design equation, the dBTechnologies team of engineers developed a line array system that is easy to configure, exceedingly light, and tremendously versatile. What's more, the managed to take all these vital criteria into account without imposing limits on curving capacity and the number of arrayed components. Called DVA, this system makes the most of line array technology's considerable audio benefits.

Leveraging state-of-the-art technologies, materials, and many years experience developing powered speaker systems, dBTechnologies has turned up a line array series that raises the performance bar for handling, versatility, and return on investment.

dBTechnologies has a competitive edge. Our engineers' deep insight into power electronics, DSP programming, acoustics, mechanics, materials, and manufacturing practices enables us to independently develop innovative solutions in each of these areas. Such comprehensive R&D proficiency puts us in a unique position: we are able to transform inspired ideas into premium-quality products that deliver outstanding performance at an unrivalled price-point.

The DVA series stands as a shining example of this all-around ability. Nowhere are the benefits of integrated amps, active crossovers, and processor-driven control more apparent than in DVA three-way line array units.

# 3-WAY ACTIVE / *Line Array Module*

## DVA T12

The global group of dBTechnologies companies develops and manufactures individual speaker components autonomously, and often specifically for the given application. We do not subscribe to the practice of equalizing and optimizing speakers with elaborate technology to bring them up to our standards. Instead, it has been our long-standing policy to build from the bottom up components with specs tailored to deliver the best audio performance for the application.

DVA T12 is a step up the evolutionary ladder from the successful DVA T4 line array system. Although it provides more power and has greater range, its active three-way design makes it just as easy to set up and install as its predecessor.

### ■ **Full of Technology**



**LONG-THROW SYSTEM**

**FULLY POWERED 3-WAY UNIT**

**FREELY SCALABLE  
TO SETUPS OF ANY SIZE**

**LOSSLESS SIGNAL PATH  
WITH NO NEED  
FOR SPEAKER CABLES**

**SEQUENTIALLY  
CONFIGURABLE  
ARRAY SEGMENTS**

**HIGH-END DIGITAL  
CONTROLLER (DSP) ON  
BOARD**

**NETWORK-READY WITH  
AN INTEGRATED RDNET PORT**

**HARDWARE COMPATIBLE  
WITH DVA T8 AND T4  
SYSTEMS**





# DVA T12

**The DVA T12** features state-of-the-art neodymium speakers and high-performance digital amps with total of 1,410W output power.

In combination with top-drawer DSP and premium quality AD-DA converter, it delivers high-definition sonic images with massive SPL for large sound reinforcement applications.

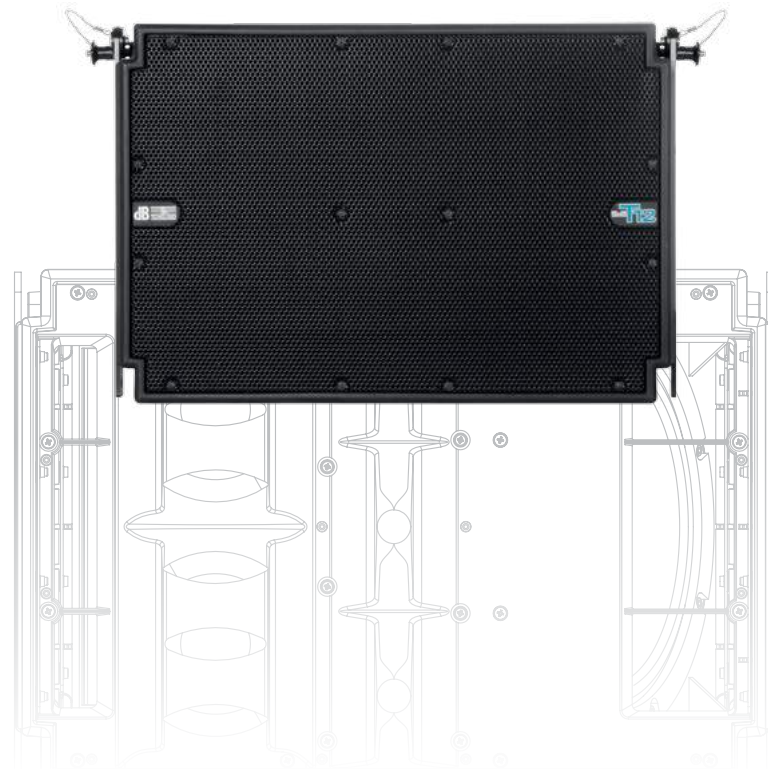

**Weighing just 29kg (63.93 lbs)**, this remarkably compact unit belies its unobtrusive look by enabling you to set up very powerful line arrays that deliver extraordinary performance.



## Technical Data

Speaker Type: 3-Way Active Line Array Module

## Acoustical data

Frequency Response [- 6dB]: 60 - 19,000 Hz

Max SPL: One Unit: 136 dB

HF: 3x1"

Voice Coil HF: 1.4"

MF: 2x 6.5"

Type MF: Neodymium Sealed Basket  
Phase Plug Horn Loaded

Voice Coil MF: 2"

LF: 12"

Type LF: Neodymium

Voice Coil LF: 3"

Directivity: 100x10° Single unit

## Amplifier

Amp Technology: Digipro® G2

Amp Class: Class-D

RMS Power: 1410 W

Peak Power: 2820 W

HF Amp: 350 W RMS (700 W Peak)

MF Amp: 350 W RMS (700 W Peak)

LF Amp: 710 W RMS (1420 W Peak)

Cooling: Convection

## Processor

Controller: DSP 28/56 bit

AD/DA Converter: 24 bit/96 kHz

System Presets: 9 (8x HF/Low-mid correction)

Limiter: Dual Active Limiter Multiband RMS,  
Peak, Thermal

Crossover Frequency MF-HF: 1800 Hz

Slope MF-HF: 24 dB/Octave

Crossover Frequency LF-MF: 420 Hz

Slope LF-MF: 24 dB/Octave

## Input/Output Section

Signal Input: 1x XLR fem. Bal.

Signal Output: 1x XLR male. Bal.

Network: RDNet remote control RJ45 connector  
IN/OUT

Power Socket: 1x PowerCon In 1x PowerCon Out

Voltage Range: 90 - 240 V-

## Mechanics

Housing: Polypropylene PP Aluminium reinforced

Housing Design: Trapezoidal 10°

Rain cover: Included

Rigging Points: Integrated rigging hardware

Width: 580 mm (23.2 in)

Height: 386 mm (15.44 in)

Depth: 430 mm (17.2 in)

Weight: 29.9 kg (63.93 lbs)

# Top performance *Combined with total control*

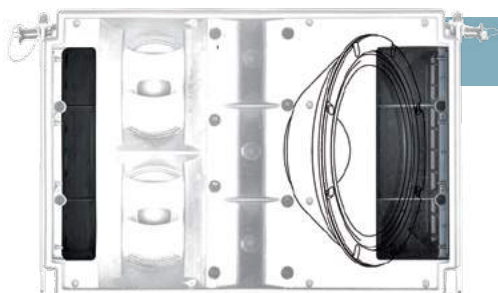

**T12 LF**

## **Extended low-end performance**

A 12" neodymium woofer in a band-pass housing covers the low frequency range. Remarkably powerful, it packs an assertive punch that reaches down to 60 Hz to enable full-range applications. The 12" woofer is slanted inside the housing, giving the cabinet a lean, unobtrusive look.

- ✦ 12" NEODYMIUM WOOFER
- ✦ FULL-RANGE CAPABILITY FROM 60HZ UP

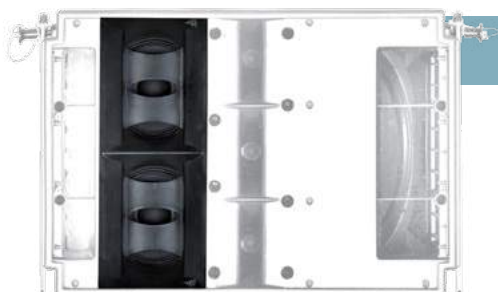

**T12 MF**

## **Accurate and awesomely efficient midrange response**

The DVA T12's two 6.5" neodymium midrange are placed close together to maximize coherent coupling and response for those critical midrange frequencies. The speaker resides in a sealed basket to optimize the displacement volume. This makes the midrange even more responsive.

With a high BL factor, it reacts far faster to transients and renders each attack with awesome accuracy. Both 6.5" midrange are equipped with an optimized phase plug and feed into a frontloaded horn to achieve a uniform coverage pattern.



**T12 HF**

## **High-definition top end**

The 1" neodymium HF drivers feature 1.4" Mylar diaphragms. Exceptionally light and responsive, they deliver richly detailed signals with remarkably linear frequency response. Specially developed for use in line arrays, these ultra compact drivers may be deployed in very close proximity to one another. This is essential to minimize interference in such arrays.

The DVA T12 is loaded with three HF drivers tuned specifically for the custom designed array horn. This combination maximizes the coupling of the drivers' outputs and extends the range of the HF signal.



**T12**

## **Consistent coverage pattern**

The DVA T12 features constant directivity horns, HF drivers, and midrange speakers optimized to deliver a uniform 100°-by-10° coverage pattern. The DVA makes the most of two acoustical effects to help distribute SPL evenly.

One is the vector addition of individual horns' output, with the other being cylindrical wave formation. The coverage pattern may be adapted to suit the sound reinforcement application by varying the length of the array and adjusting the splay between individual components.

- ✦ UNIFORM 100°-BY-10° COVERAGE PATTERN
- ✦ EVENLY DISTRIBUTED SPL

# DVA T12



## Ground stacks

DRK-10 and DRK-20 harnesses can also serve to stack cabinets on the ground when rigging points are unavailable or the ceiling is too low. A special bracket adjusts the inclination down to 7.5°. The DRK-10/20 fits perfectly on an upright DVA S30 subwoofer. Equipped with two receptacles for quick-release pins, it is readily attached without tools.

The DVA S30 subwoofer sports two 18" speakers, a bass reflex horn, a 3000W power amp, and an internal DSP. (To learn more about it, see the chapter entitled Active Subwoofer).

- ✦ LINE ARRAY BENEFITS IN GROUND-STACKED CONFIGURATIONS

## Compatible with DVA T8

DVA T12 and DVA T8 series housings and rigging hardware are compatible.

This means DVA T8 units may be flown right below a T12 array for use as down-fills in large PA systems.

- ✦ COMPATIBLE DVA T8'S MAY SERVE AS FAR-FILL EXTENSIONS

## Simple system configuration & networked remote control

Presets containing gain structure and EQs for the near-field/mid-field and far-field positions can be easily selected using the rear mounted rotary encoder or via RDNET protocol with Aurora Net software. This application also allows complete surveillance and control of the system assuring best performance and total safety.

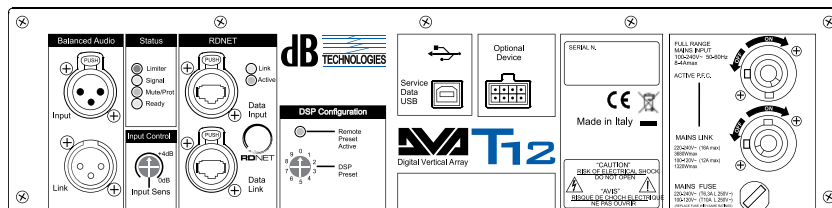



# 3-WAY ACTIVE / *Line Array Module*

## DVA T8

DVA T8 is the most advanced incarnation of a string of successful line array systems that started with the DVA T4. Loaded with state-of-the-art neodymium woofers, the DVA T8 features a high-performance digital power amp with 700W RMS total output, a high-end 28/56-bit DSP, and premium-quality AD-DA converters.

These superior components come together to deliver superior audio quality and high SPL. Remarkably easy to handle, this lightweight, 14.2kg line array's powerful performance belies its look of subdued elegance and small footprint.

It's hard to believe that something so petite can pack such a mighty punch.

### ■ **Full of Technology**



**3-WAY ACTIVE  
WITH A 700W/RMS  
DIGITAL POWER AMP**

**HIGH-END 56-BIT DSP  
ON BOARD**

**96 KHZ SAMPLING RATE**

**NETWORK-READY WITH  
AN INTEGRATED RDNET PORT**

**SIX MODULES CONNECTED  
TO ONE 16A PHASE PLACE**

**LOSSLESS SIGNAL PATH  
WITH NO NEED  
FOR SPEAKER CABLES**

**ACOUSTICALLY COMPATIBLE  
WITH THE DVA T12**

**MECHANICALLY COMPATIBLE  
WITH THE DVA T12**





# DVA T8

## Top Performance Paired with Total Control

The DVA T8 is a fully active, three-way speaker system equipped with the same innovative technologies that feature so prominently in the DVA T12.

Its power supply, DSP, power amps, woofers and drivers were all developed and painstakingly tuned specifically for the DVA T8 system by the dBTechnologies team of engineers.

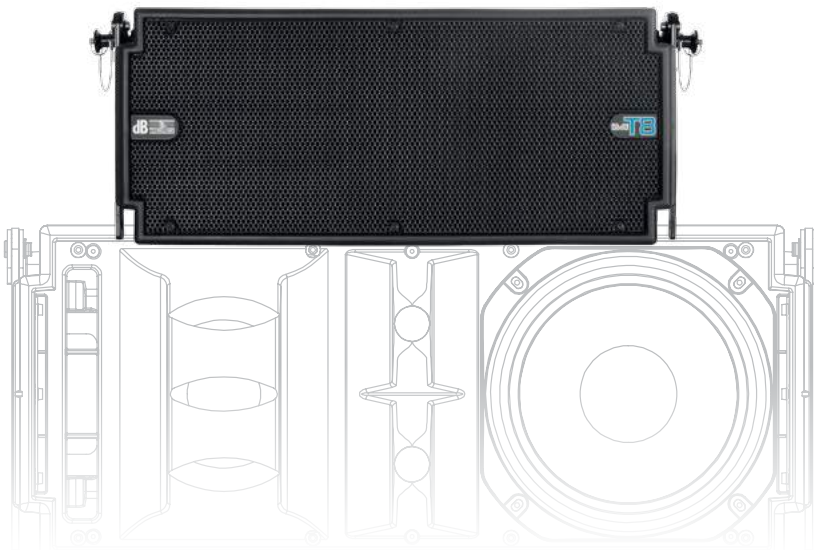

## Precise directivity

The DVA T8 sports constant directivity horns, HF drivers, and midrange woofers optimized to deliver a uniform 100°-by-15° coverage pattern. It makes the most of two acoustical effects to help distribute SPL evenly.

One is the vector addition of individual horns' output; the other is cylindrical wave formation. These two effects come together to create a uniform coverage pattern that is easily adapted to different venues by varying the length of the array and adjusting the splay between individual components.

- + UNIFORM COVERAGE PATTERN
- + EVENLY DISTRIBUTED SPL



### Technical Data

Speaker Type: 3-Way Active Line Array Module

### Acoustical data

Frequency Response [-6dB]: 66 - 18,000 Hz

Max SPL: One Unit: 132 dB

HF: 2x 1"

Voice Coil HF: 1.4"

MF: 1x 6.5"

Type MF: Neodymium Sealed Basket Phase Plug Horn Loaded

Voice Coil MF: 2"

LF: 8"

Type LF: Neodymium

Voice Coil LF: 2.5"

Directivity: 100x15° Single unit

### Amplifier

Amp Technology: Digipro® G2

Amp Class: Class-D

RMS Power: 700 W

Peak Power: 1400 W

HF Amp: 175 W RMS (350 W Peak)

MF Amp: 175 W RMS (350 W Peak)

LF Amp: 350 W RMS (700 W Peak)

Cooling: Convection

### Processor

Controller: DSP 28/56 bit

AD/DA Converter: 24 bit/96 kHz

System Presets: 9 (8xHF and Low-mid correction)

Limiter: Dual Active Limiter Multiband RMS, Peak, Thermal

Crossover Frequency MF-HF: 1900 Hz

Slope MF-HF: 24 dB/Octave

Crossover Frequency LF-MF: 400 Hz

Slope LF-MF: 24 dB/Octave

### Input/Output Section

Signal Input: 1x XLR fem. Bal.

Signal Output: 1x XLR male. Bal.

Network: RDNet remote control RJ45 connector IN/OUT

Power Socket: 1x Powercon In + 1x Powercon Out

Voltage Range: 90 - 240 V-

### Mechanics

Housing: Polypropylene PP Metal reinforced

Housing Design: Trapezoidal 15°

Rain cover: Included

Rigging Points: Integrated rigging hardware

Width: 580 mm (23.2 in)

Height: 240 mm (9.6 in)

Depth: 327 mm (13.08 in)

Weight: 14.2 kg (31.3 lbs)

# Top performance *Combined with total control*



**T8 LF**

## Extended low-end performance

A powerful 8" neodymium woofer, paired with a 350W power amp, covers the low frequency range with an assertive punch that reaches down to 70 Hz.

- ✦ 8" NEODYMIUM WOOFER
- ✦ FULL-RANGE CAPABILITY FROM 70 HZ UP



**T8 MF**

## Accurate, awesomely efficient midrange response

Loaded with a custom 6.5" neodymium midrange, the DVA T8 also delivers excellent midrange response, which has such a formative influence on shaping the sonic image. The midrange is housed in a sealed chassis. Its high BL factor makes it even more responsive so that it renders transients faithfully. A phase plug feeds into a frontloaded horn tuned to achieve a uniform coverage pattern.

- ✦ ONE 6.5" NEODYMIUM MIDRANGE WITH A FRONTLOADED HORN
- ✦ SUPERIOR TRANSIENT RESPONSE



**T8 HF**

## High-definition top end

The 1" neodymium HF drivers feature 1.4" Mylar diaphragms. Exceptionally light and responsive, they deliver richly detailed signals with remarkably linear frequency response. Developed especially for use in line arrays, these drivers may be deployed in very close proximity to one another. This is essential to minimize interference in such arrays.

- ✦ TWO 1" NEODYMIUM HF DRIVERS WITH ARRAY HORN
- ✦ REMARKABLY TRANSPARENT RESPONSE



## Durable yet light hybrid polypropylene enclosure

This enclosure's surface is immune to knocks and scratches and fully resistant to water and moisture. A sophisticated metal skeleton provides internal bracing that connects its component parts, reinforces the housing and softens resonance.

- ✦ METAL-REINFORCED POLYPROPYLENE HOUSING
- ✦ LIGHT YET EXCEEDINGLY DURABLE
- ✦ INTEGRATED RAIN PROOFING

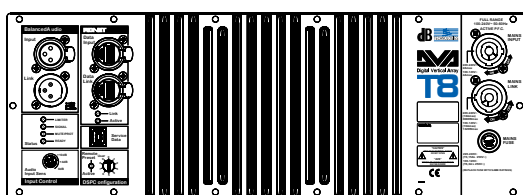

## High reliability and operating safety

The processor monitors amp's temperature, voltage, current, impedance, input, output, and other data independently and continuously. It detects problems such as an impending overload, and attenuates the signal gradually in small steps or mutes it altogether, depending on the given temperature and level.

- ✦ REAL-TIME OPERATING STATUS MONITORING
- ✦ STATUS REPORT DELIVERY VIA THE DVA USB MANAGER

# DVA T8



## Extraordinary dynamic range and natural sound

The DVA T8's signal processors and AD/DA converters were engineered to achieve transcendent sound quality with great fidelity and dynamic range with 56-bit digital signal processing at a sampling rate of 96 kHz.

DSPs equalize every signal path, aligning phases and time, and handle loads with digital peak, RMS, and thermal limiters to maximize operating safety, power management and performance even at threshold levels.

- ✦ EXCELLENT AUDIO SPECS
- ✦ PERFECT SYSTEM EQUALIZATION

## Easy setup - configuration at the touch of a button

The DVA T8's DSP offers eight system presets that adapt the unit to its assigned task in the array.

They adjust the gain structure and EQ for the near-field/midfield and far-field positions to compensate for high frequencies absorbed by air as well as for low/midrange frequency coupling as the array length increases. No further manual adjustments are necessary. All presets may be selected using the rear-mounted rotary encoder or downloaded from a PC using RDNet software.

- ✦ SIMPLEST SYSTEM CONFIGURATION
- ✦ VERY FAST SETUP

## SMPS with PFC for consistently superb performance

The DVA T8's power supply consists of independent networked devices. Incorporating the latest IT technology, it was engineered to maximize operating safety, efficiency, and performance.

The main 750W power supply provides plenty of juice to the power amps and features PFC (power factor correction). A secondary power supply feeds the microcontrollers and the DSP, and serves to ramp up check routines and the main power supply. The smart IPOS™ (Intelligent Power-On Sequence) circuit keeps the overall system's inrush current low.

- ✦ WIDE-RANGE 90-TO-240V SMPS POWER SUPPLY WITH PFC
- ✦ IPOS™ CIRCUIT FOR LOW INRUSH CURRENT

## Handling, Stacking and Flying Cabinets

The DVA T8 comes with built-in rigging hardware. The splay between enclosures may be adjusted in increments from 0° to 15°. The DRK-10 harness holds up to 16 flown T8 units. At just 14.2 kg, the DVA T8 is exceptionally light so an array with six elements weighs less than 100 kg. This is an advantage greatly appreciated by everyone who handles and transports the array.

A single person can rig up and fly the system, even from trusses and towers rated to handle lighter loads.

- ✦ VERY LIGHT POINT LOAD
- ✦ PRECISE ALIGNMENT
- ✦ DRK-10 HARNESS FLIES UP TO 16 UNITS



# HIGH PERFORMANCE / *Subwoofer Systems*

## DVA SUBS

DVA bass bins are loaded with state-of-the-art, high-performance subwoofers.

Equipped with powerful woofers, featuring voice coils ranging from up to 4" diameters, these units' load handling capacity is extremely high, and their transient response is remarkably faithful.

The dual ventilation system minimizes heat buildup and power compression while helping to maximize loading handling capacity and reliability.

The woofers feature a fiberglass-reinforced diaphragm, an exceedingly robust triple-roll surround, and a geometrically optimized cone. All this culminates in peak-to-peak excursion capabilities ranging up to 48 mm.

### ■ **Full of Technology**

#### **VARIABLE CROSSOVER FREQUENCIES**

These subwoofers are driven by digipro® G2 digital power amps with up to 3000W output. Digipro® G2 technology is so very efficient that it does not require fans. With no moving parts to tend to, these amps are altogether maintenance-free.

#### **PRECISE LIMITER FUNCTIONS**

Equipped with PFC switched-mode power supplies, they are largely impervious to line voltage fluctuations, which is a tremendous asset in a touring rig.

#### **ON BOARD DELAY FOR PERFECT TIME ALIGNMENT**

Our network-enabled DVA subwoofers are designated by an "N" in the product name. They feature a premium-quality DSP boasting excellent audio specs with variable crossover frequencies, precise limiter functions and adjustable delay settings for perfect time alignment.

#### **PRESET FOR CONFIGURING CARDIOID SYSTEMS**

A special preset makes it easy to set up cardioid systems with enhanced directivity. Settings are readily adjusted using the rear-mounted rotary encoder. The DSP also provides an X-Over output for connecting satellites (in stereo on S08 and S09 units).

#### **SETTINGS ACCESSIBLE VIA A ROTARY ENCODER**

Factory-equipped with an RDNet port, these subwoofers are ready for integration into elaborate, remotely controlled and monitored DVA T12 sound reinforcement systems via RJ45 inputs and outputs that connect the units to the RDNet hub.

#### **X-OVER OUT**

Made of sturdy multiplex covered in robust black textured lacquer, the subwoofer housing is fronted with a rugged speaker grille. The enclosure is easy to tote with its comfortable carrying handles.

#### **RDNET NETWORK PORT**

Optional dust covers protect it on the go. With 16 threaded bushings each on their rear panels, the S09, S10, S30N, S1518N, 1521N and S20 bins are ready to accept Blue Wheels. Retrofitted with the appropriate fly kit, S09, S10, 1518N and 2585N subwoofers are easily rigged and flown.





## DVA S30 N Subwoofer, 2x 18" Bassreflex Horn Loaded

Featuring a dual 18" subwoofer pairing in a bass reflex housing, the DVA S30 packs a muscular, ultra lowfrequency punch.

It delivers very powerful performance indeed with a range extending down to the lowest frequencies.

This sub-bass powerhouse is the perfect addition to large PAs and an excellent complement to DVA T12 mid-/high-range units in stacked arrays.

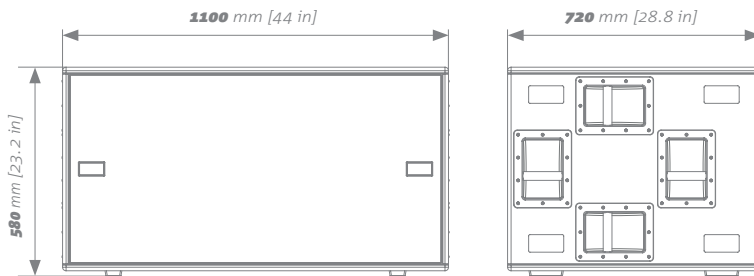

### Bass reflex horn housing

This sophisticated hybrid design brings together the benefits of bass reflex and horn systems in a compact housing engineered to render low frequencies with high SPL.

The two baffle boards are arrayed in the form of a V. They guide the central bass reflex channel's sound energy into the horn's port. This funneling action is smooth and uniform, greatly increasing its range.

The high-quality multiplex housing is covered in robust black textured lacquer and equipped with eight carrying handles.

On the back is a transport dolly that removes easily via quick-release pins to keep the wheels from rattling.



# DVA S30 N

### Technical Data

Speaker Type: Active Bassreflex-Horn Subwoofer

### Acoustical data

Frequency Response [+/-3dB]: 30 - 120 Hz

Max SPL: 141 dB

Directivity: Omnidirectional.

Cardiod Option with DSP setup

LF: 2x18"

Voice Coil LF: 4"

### Amplifier

Amp Technology: DigiPro® G2

Amp Class: Class-D

Power Supply: 3 kW SMPS with PFC

RMS Power: 3000 W

Peak Power: 6000 W

Cooling: Convection

### Processor

Controller: DSP 28/56 bit

AD/DA Converter: DSP 24 bit/96 kHz

System Presets: X-Over, Delay

Phase: 0, 180°

Limiter: RMS, Peak, Thermal

Delay Option: 0-4.5 ms internal

Crossover Frequency LF-HF: 75-120Hz|steps of 5Hz

LF-Xover out slope: 24 dB/Octave

### Mechanics

Housing: Multiplex plywood

Housing Design: Rectangular

Handles: 4x Per Side

Accessory: Dolly, Wheels 100mm.

Dust Cover, Rain Cover

Rigging Points: 2xPick Points on top to fix

DRK10/20 rigging frames

Width: 1100 mm (44 in)

Height: 580 mm (23.2 in)

Depth: 720 mm (28.8 in)

Weight: 83 kg (182.98 lbs)

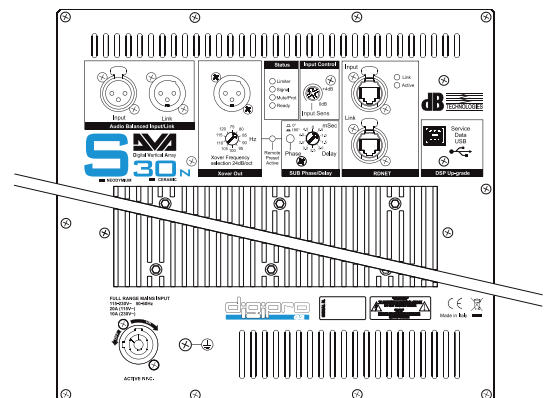



# DVA S1521 N



## DVA S1521 N Subwoofer, 21" Bassreflex

The DVA S1521 N is a powered 21" subwoofer housed in a bass reflex enclosure that we tuned for accurate, ultra low-frequency response.

It readily integrates into large DVA and DVX Series PA systems as a sub-bass unit or as a stacked subwoofer.

Made of durable multiplex housing covered in robust black textured lacquer, the high-quality housing provides six carrying handles, an M20 pole mount, and bushings on the rear panel that accept casters. Pick-points for attaching DRK-10 and DRK-20 harnesses are built into the top panel to enable easy, safe stacking.

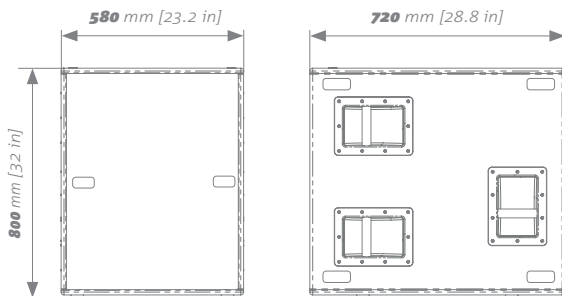

### Top-notch 21" woofer

Serving as the unit's transducer is a state-of-the-art 21" woofer with 4.5" voice coil.

This combination of high-quality materials and sophisticated magnetic drivers fields some pretty impressive results.

Even very low bass frequencies are rendered with pinpoint precision and hairtrigger transient response, treating audiences to a breathtaking audio experience.



### Technical Data

Speaker Type: Active Bassreflex-Subwoofer

### Acoustical data

Frequency Response [+/-3dB]: 30 - 105 Hz  
 Max SPL: 139 dB  
 Directivity: Omnidirectional.  
 Cardioid Option with DSP setup  
 LF: 21"  
 Voice Coil LF: 4.5"

### Amplifier

Amp Technology: Digipro® G2  
 Amp Class: Class-D  
 Power Supply: 1.5 kW SMPS with PFC  
 RMS Power: 1500 W  
 Peak Power: 3000 W  
 Cooling: Convection

### Processor

Controller: DSP 28/56 bit  
 AD/DA Converter: 24bit/96 kHz  
 System Presets: X-Over, Delay  
 Phase: 0, 180°  
 Limiter: RMS, Peak, Thermal  
 Delay Option: 0-4.5 ms internal  
 Crossover Frequency LF-HF: 60-105Hz/Steps of 5Hz  
 LF-Xover out slope: 24 dB/Octave

### Mechanics

Housing: Multiplex plywood  
 Housing Design: Rectangular  
 Handles: 3x Per Side  
 Accessory: Wheels 100mm, Dust Cover, Rain Cover  
 Pole Mount: M20  
 Rigging Points: 2xPick Points on top to fix DRK10/20 rigging frames  
 Width: 580 mm (23.2 in)  
 Height: 800 mm (32 in)  
 Depth: 720 mm (28.8 in)  
 Weight: 52.5 kg (115.74 lbs)

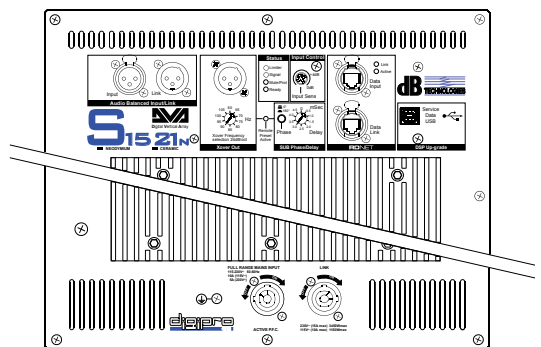



## DVA S1518 N Subwoofer, 18" Bandpass

The DVA S1518 N is a bandpass subwoofer based on the DVA S10, but with 50 percent higher power amp output, an integrated DSP, and an RDNNet link.

A remarkably versatile subwoofer, it delivers tight and punchy bass response that supports and transitions smoothly to satellites' lower midrange frequencies.

The DVA S1518 N is equipped with a next-generation, 18" woofer driven by a built-in 1500W digipro® G2 digital power amp.

Subwoofer arrays are easily flown using the optional SRK10 rigging hardware retrofit.

The S1518 N will also serve you well in compact stacks paired with DVA T12, T8 and T4 units or DVX Series enclosures.

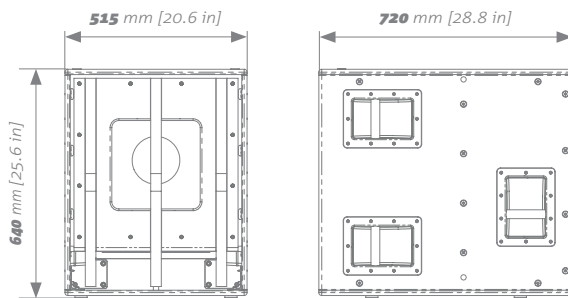

# DVA S1518 N

### Technical Data

Speaker Type: Active Bandpass Subwoofer

### Acoustical data

Frequency Response [+/- 3dB]: 39 - 120 Hz

Max SPL: 138 dB

Directivity: Omnidirectional.

Cardiod Option with DSP setup

LF: 18"

Voice Coil LF: 4"

### Amplifier

Amp Technology: Digipro® G2

Amp Class: Class-D

Power Supply: 1.5 kW SMPS with PFC

RMS Power: 1500 W

Peak Power: 3000 W

Cooling: Convection

### Processor

Controller: DSP 28/56 bit

AD/DA Converter: 24bit/96 kHz

System Presets: X-Over, Delay

Phase: 0, 180°

Limiter: RMS, Peak, Thermal

Delay Option: 0-4.5 ms internal

Crossover Frequency LF-HF: 75-120Hz |steps of 5Hz

LF-Xover out slope: 24 dB/Octave

### Mechanics

Housing: Multiplex plywood

Housing Design: Rectangular

Handles: 3x Per Side

Accessory: Dolly, Wheels 100mm,

Dust Cover, Rain Cover

Pole Mount: M20

Rigging Points: integrated for SRK10 fly kit

2xPick Points on top to fix

DRK10/20 rigging frames

Width: 515 mm (20.6 in)

Height: 640 mm (25.6 in)

Depth: 720 mm (28.8 in)

Weight: 46 kg (101.41 lbs)

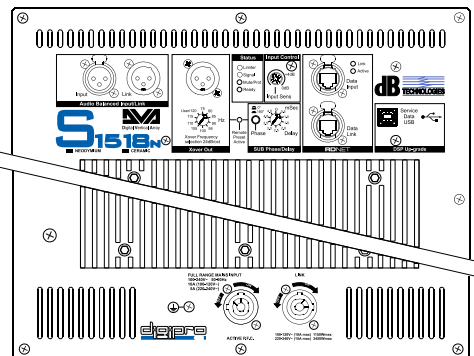





# DVA S2585 N



## DVA S2585 N Subwoofer, 18" + 15" Cardioid

The DVA S2585 N is a compact subsystem featuring a cardioid layout designed for utmost directivity.

The system consists of two separate chambers, one loaded with a forward facing 18" woofer and another with a rearward facing 15" woofer. The integrated digipro®G2 digital power amps provide 2500W total output power. The high-quality DSP filters signals and controls the speakers to deliver a remarkably authentic audio image and faithful transient response.

The housing is ready to fly with the optional SRK10 Rigging Kit is all it takes to put up flown cardioid sub arrays.

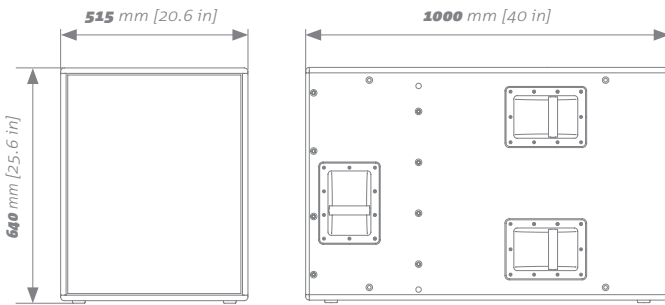

### Cardioid-Design

Many systems lack low-frequency directivity and, as a result, are plagued by interference and annoying noise.

The S2825 N, in contrast, was engineered specifically for enhanced low-frequency directivity. And it not only sounds great, it is also easy to handle and transport.



### Technical Data

Speaker Type: Active Cardioid-Subwoofer

### Acoustical data

Frequency Response (+/- 3dB): 35 - 120 Hz  
 Max SPL: 140 dB  
 Directivity: Cardioid  
 LF: 18"+15"  
 Voice Coil LF: 4"

### Amplifier

Amp Technology: Digipro® G2  
 Amp Class: Class-D  
 Power Supply: 2.5 kW SMPS with PFC  
 RMS Power: 2500 W  
 Peak Power: 5000 W  
 Cooling: Convection

### Processor

Controller: DSP 28/56 bit  
 AD/DA Converter: 24bit/96 kHz  
 System Presets: X-Over, Delay  
 Phase: 0, 180°  
 Limiter: RMS, Peak, Thermal  
 Delay Option: 0-4.5 ms internal  
 Crossover Frequency LF-HF: 75-120Hz | steps of 5Hz  
 LF-Xover out slope: 24 dB/Octave

### Mechanics

Housing: Multiplex plywood  
 Housing Design: Rectangular  
 Handles: 3x Per Side  
 Accessory: Dolly, Dust Cover, Rain Cover  
 Pole Mount: M20  
 Rigging Points: integrated for SRK10 fly kit  
 2x Pick Points on top to fix  
 DRK10/20 rigging frames  
 Width: 515 mm (20.6 in)  
 Height: 640 mm (25.6 in)  
 Depth: 1000 mm (40 in)  
 Weight: 65 kg (143.3 lbs)

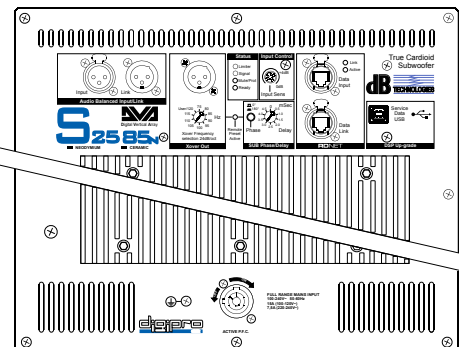



# DVA S09 DP



## DVA S09 Subwoofer

A remarkably compact 15" subwoofer in a band-pass design, the DVA S09 DP delivers true, tight, and punchy bass response. With a height of just 44 cm, it can be flown above DVA T4 modules to keep the footprint of the rig inconspicuous.

The S09 comes with two features that make it the perfect base for a high-quality satellite system, for example, when paired with the DVX D10. One is an integrated active stereo crossover with two cutoff frequencies to choose from, 90Hz and 120Hz. The other is a phase inversion switch. One PowerCon socket connects to the mains power supply, while two PowerCon outputs connect satellites.

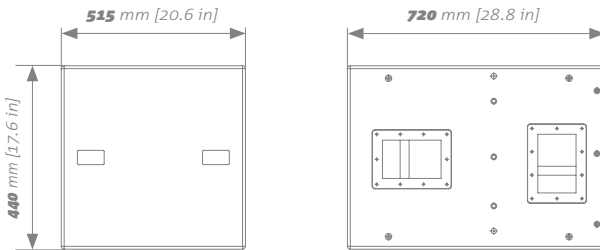

## SRK-09 Fly Kit

Retrofitted with the optional SRK-09 fly kit, the DVA S09 DP subwoofer is easily rigged to a DRK-10 harness and flown alongside further DVA T4 mid-/high-range units.



### Technical Data

Speaker Type: Active Bandpass Subwoofer

### Acoustical data

Frequency Response [ $\pm$  3dB]: 45 - 120 Hz

Max SPL: 134 dB

Directivity: Omnidirectional

LF: 15"

Voice Coil LF: 4"

### Amplifier

Amp Technology: Digipro®

Amp Class: Class-D

RMS Power: 1000 W

Peak Power: 2000 W

Cooling: Convection

### Processor

Controller: Analog (Stereo)

Phase: 0, 180°

Limiter: RMS, Peak, Thermal

Delay Option: NO

Crossover Frequency LF-MF: 90, 120 Hz

LF-Xover out slope: 24 dB/Octave

### Mechanics

Housing: Multiplex plywood

Housing Design: Rectangular

Color: Black, White

Handles: 2x Side

Pole Mount: 1x M20

Rigging Points: 2x Pick Points on top to fix

DRK10/20 rigging frames

Accessory: Wheels 100mm, Dust Cover, Rain Cover

Width: 515 mm (20.6 in)

Height: 440 mm (17.6 in)

Depth: 720 mm (28.8 in)

Weight: 37.5 kg (82.67 lbs)

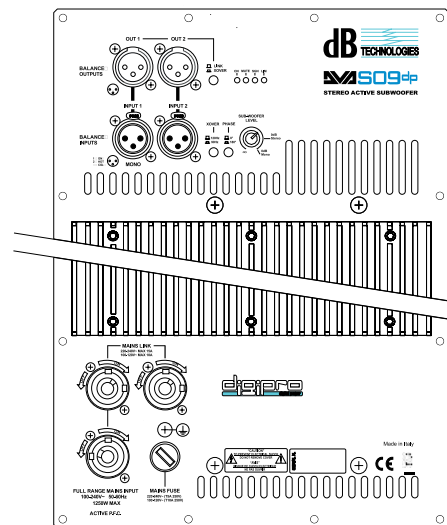



# DVA S08 DP



## DVA S08 Subwoofer

The DVA S08 DP is a remarkably compact 12" high power active bassreflex subwoofer for professional applications and to satisfy upmarket requirements.

It delivers a high momentum and at the same time reproduces a punchy low end. Equipped with a 800W/RMS Digipro® digital power amp including switch mode supply, this unit provides a high sound pressure level of up to 131dB. Furthermore there is a powercon in and out for mains connection.

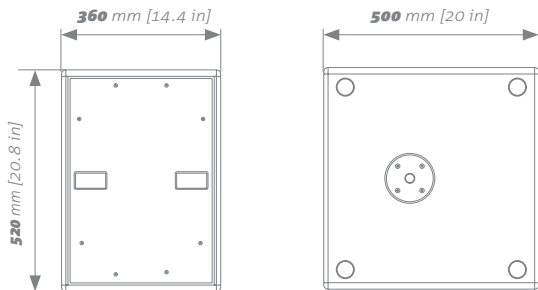

### Technical Data

Speaker Type: Active Bassreflex Subwoofer

### Acoustical data

Frequency Response [+/- 3dB]: 40 - 150 Hz

Max SPL: 131 dB

Directivity: Omnidirectional

LF: 12"

Voice Coil LF: 3"

### Amplifier

Amp Technology: Digipro®

Amp Class: Class-D

RMS Power: 800 W

Peak Power: 1600 W

Cooling: Convection

### Processor

Controller: Digital + Analog (Stereo)

Phase: 0, 180°

Limiter: RMS, Peak, Thermal

Delay Option: NO

Crossover Frequency LF-MF: 90, 120 Hz

LF-Xover out slope: 24 dB/Octave

### Mechanics

Housing: Multiplex plywood

Housing Design: Rectangular

Handles: 1x on top

Pole Mount: 2x M20

Accessory: Dust Cover

Width: 360 mm (14.4 in)

Height: 520 mm (20.8 in)

Depth: 500 mm (20 in)

Weight: 23 kg (50.71 lbs)

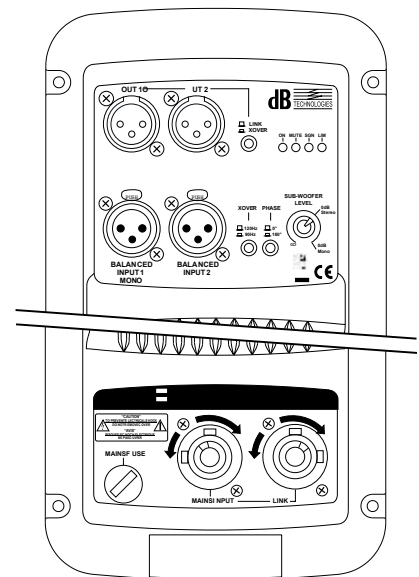

# 3-WAY ACTIVE / *Line Array Module*

## DVA K SERIES

dBTechnologies' active line array series DVA has set new standards in the sound reinforcement industry since its market launch in 2006.

Equipped with top-notch features and engineered for maximum versatility, DVA T and DVA M series brought the benefits of line array technology to a much wider range of users.

Now dBTechnologies upgrades the best of technology that determined the success of the whole series in the new 3 way active line array module DVA K5 and active subs DVA KS10 and DVA KS20.

Featuring technological upgrades partially derived from dBTechnologies' flagship series DVA T, DVA K5 aims to inherit the international success of the series.

### ■ **DVA Evolution**



**ADVANCED DSP WITH FIR  
FILTERS PROCESSING**

**FULLY COMPATIBLE  
WITH DVA T FLYING  
AND GROUNDSTACKING  
ACCESSORIES**

**NEW GRILLE DESIGN**

**ON BOARD DOUBLE ROTARY  
TUNING SYSTEM**



# Top performance

Combined with total control

## DVA K5

### DVA's evolution: a new concept in line array technology

Featuring a Class-D 500 W RMS Digipro® G3 digital amplifier, DVA K5 is capable to reach up to 129 dB SPL and aims to inherit the success of the earliest model of the series DVA T4. The new DVA line array module comprises 2x 1.4" compression drivers, a 6.5" neodymium midrange and a 8" neodymium woofer.

Thanks to FIR filters technology, a new dual rotary encoder DSP user interface allows an extremely precise system tuning. The module's electronics and components are housed in a sturdy polypropylene box, reinforced with an internal anti-vibration metal structure that allows the cabinet to achieve an excellent acoustic response. DVA K5 comes with a freshly designed frontal grille and an integrated raincover.



### Flying the cabinets

DVA K5 comes with the same precisely engineered flying hardware that determined the success of DVA T series. The curving of the array can be adjusted within a range between 0° and 15°.

The cabinets are fully compatible with DVA T series flying and groundstacking accessories.

Their compact size combined with their low-weight makes flying option possible even in those venue where the trussing system can't usually support audio devices, an array of 6 DVA K5 weighting less than 100 Kg.



### Technical Data

Speaker Type: 3-Way Active Line Array Module

### Acoustical data

Frequency Response [+/- 3dB]: 70 - 19.000 Hz

Max SPL: One Unit: 129 dB

HF: 2 x 1"

Voice Coil HF: 1.4"

MF: 1x 6.5"

Type MF: Neodymium

Voice Coil MF: 2"

LF: 1x 8"

Type LF: Neodymium

Voice Coil LF: 2.5"

Directivity [H x V]: 100° x 15° Single unit

### Amplifier

Amp Technology: Digipro® G3

Amp Class: Class-D

RMS Power: 500 W

Peak Power: 1000 W

Cooling: Convection

Power Supply: 500 W SMPS with Auto-range PSU

### Processor

Controller: DSP 28/56 Bit

AD/DA Converter: 24 bit/48 kHz

Limiter: Dual Active Limiter Multiband RMS, Peak, Thermal

Crossover Frequency MF-HF: 1800 Hz

Slope MF-HF: 24 dB/Octave

Crossover Frequency LF-MF: 340 Hz

Slope LF-MF: 24 dB/Octave

### Input/Output Section

Input Section: 1x XLR balanced

Output Section: 1x XLR balanced

Power Socket: 1x Powercon In + 1x Powercon Out

Controls: 1 x Input Sensitivity Rotary Switch

1 x DSP Rotary Encoder (LF Correction)

1 x DSP Rotary Encoder (MF-HF Correct)

### Mechanics

Housing: Polypropylene PP Metal reinforced

Rigging Points: Integrated rigging hardware

Width: 580 mm (23.2 in)

Height: 240 mm (9.6 in)

Depth: 327 mm (13.08 in)

Weight: 14.2 kg (31.3 lbs)

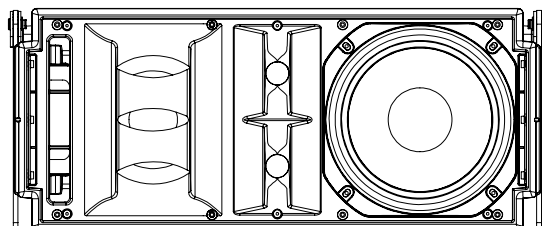



**K5 LF**

### **Extended low-end performance**

The 8" neodymium woofer is equipped with a high power 2.5" voice coil to provide energetic sound pressure level in a very compact size.

- ✦ 1x 8" NEODYMIUM WOOFER
- ✦ FULL-RANGE CAPABILITY FROM 70 HZ UP



**K5 MF**

### **Accurate, awesomely efficient midrange response**

The 6.5" neodymium midrange lies in a sealed basket and features a horn exit including a phase plug in order to provide a superb sound reproduction as well as a linear and well-defined sound emission.

- ✦ 1x 6.5" NEODYMIUM MIDRANGE WITH A FRONTLOADED HORN + PHASE PLUG
- ✦ SUPERIOR TRANSIENT RESPONSE



**K5 HF**

### **High-definition top end**

The 2 constant directivity drivers are equipped with a 1.4" membrane allowing a very quick response together with a linear frequency range.

- ✦ 2x 1" HF DRIVERS WITH ARRAY HORN
- ✦ REMARKABLY TRANSPARENT RESPONSE



### **Durable yet light hybrid polypropylene enclosure**

The unique design, the selected components and a state of the art amplifying technology come together to deliver an exceptional weight-performance ratio: each system weights 31.31 lbs (14.2 Kg).

DVA K5 also features a freshly designed frontal grille and an integrated raincover.

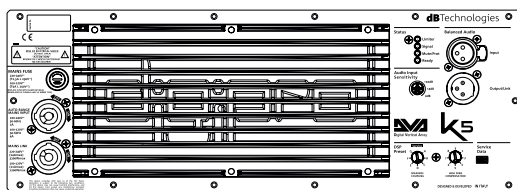

### **Advanced user interface**

DVA K5's DSP processing has been update in order to allow an extremely precise system tuning: a double rotary encoder system actually provides a separate tuning for LF correction (coupling) and MF/HF correction (high-angle midrange loss and air absorption compensation due to throw distance).

- ✦ REAL-TIME OPERATING STATUS MONITORING
- ✦ STATUS REPORT DELIVERY VIA THE DVA USB MANAGER



## Active Bass reflex-horn loaded subwoofer

Featuring a double 18" woofer pairing in a bass reflex housing, the DVA KS20 is equipped with with 2 Digipro® G3 amplifiers delivering a total power of 1800 W RMS.

The system's internal design brings together the benefits of bass reflex and and horn system in a compact sturdy housing covered with robust black laquer. The 28/56 Bit DSP manages limiters and delays, for flawless system processing.

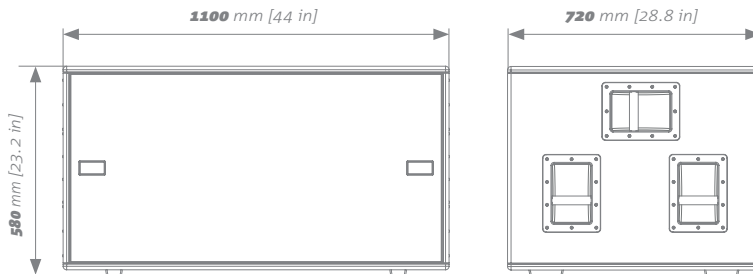

DVA KS20 is the perfect low end complement for larger DVA K5 PA systems.

Thanks to the DRK-10/20 pick points on side, the sub can be used vertically for groundstacked configurations.



# DVA KS20

## Technical Data

Speaker Type: Active Bassreflex-Horn Subwoofer

## Acoustical data

Frequency Response [-10dB]: 41 - 120 Hz  
 Max SPL: 138 dB  
 Directivity: Omnidirectional  
 LF: 2x18"  
 Voice Coil LF: 4"

## Amplifier

Amp Technology: Digipro® G3  
 Amp Class: Class-D  
 RMS Power: 1800 W  
 Peak Power: 3600 W  
 Cooling: Convection  
 Power Supply: 1800 W SMPS with Auto-range PSU

## Processor

Controller: DSP 28/56 bit  
 AD/DA Converter: 24 bit/48 kHz  
 System Presets: X-Over, Delay  
 Limiter: Dual Active Limiter Multiband RMS, Peak, Thermal  
 Crossover Frequency LF-HF: 90-120Hz (selectable)  
 Slope LF-HF: 24 dB/Octave

## Input/Output Section

Input Section: 2x XLR balanced  
 Output Section: 2x XLR balanced  
 Power Socket: 1x Powercon In + 1x Powercon Out  
 Controls: 1x Input Sensitivity Rotary Switch  
 1x DSP Rotary (Delay 4.5 ms on-board)  
 1x Polarity Inversion Switch (0°, 180°)  
 1x X-Over Frequency Switch (90, 120 Hz)  
 1 x Outputs Mode Switch (Link - X-Over)

## Mechanics

Housing: Multiplex plywood  
 Handles: 3x Per Side  
 Pole Mount: 1x M20 on top  
 Rigging Points: 2xPick Points on top to fix DRK10/20 rigging frames  
 Width: 1100 mm (44 in)  
 Height: 580 mm (23.2 in)  
 Depth: 720 mm (28.8 in)  
 Weight: 84 kg (185.19 lbs)

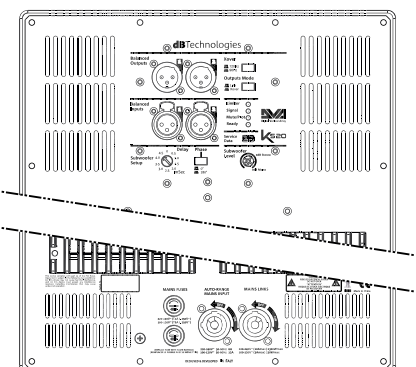

# DVA KS10



## Semi-horn loaded Active subwoofer

The semi-horn loaded subwoofer DVA KS10 is equipped with a single 18" woofer driven by a Class-D Digipro® G3 power amp delivering 1800 W peak and reaching 134 dB SPL.

Maximum versatility is granted by a stereo input/output balanced pre-amp. A dedicated encoder allows to apply up to 4.5 milliseconds of delay, with half-millisecond steps, and a switch allows to invert the polarity by 180°.

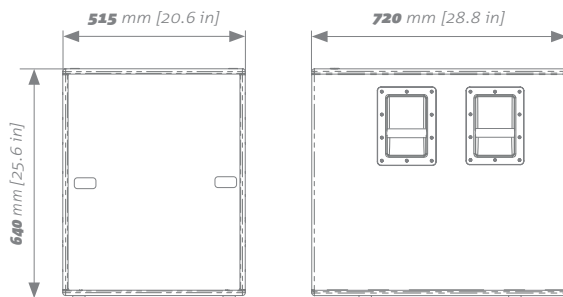

## Versatile low frequencies completion

Crucially, thanks to the optionally available SRK-10 rigging kit, DVA KS10 can be easily flown.

The bass bin can be easily used also in groundstacked configurations or as a compact PA system together with DVA K5 on speaker pole (with DSA-4 accessory).



### Technical Data

Speaker Type: Active Semi-Horn loaded Flyable Subwoofer

### Acoustical data

Frequency Response [-10dB]: 41 - 120 Hz  
 Max SPL: 134 dB  
 Directivity: Omnidirectional  
 LF: 18"  
 Voice Coil LF: 4"

### Amplifier

Amp Technology: Digipro® G3  
 Amp Class: Class-D  
 RMS Power: 900 W  
 Peak Power: 1800 W  
 Cooling: Convection  
 Power Supply: 900 W SMPS with Auto-range PSU

### Processor

Controller: DSP 28/56 bit  
 AD/DA Converter: 24bit/48 kHz  
 Limiter: Dual Active Limiter Multiband RMS, Peak, Thermal  
 Crossover Frequency LF-HF: 90, 120Hz (selectable)  
 Slope LF-HF: 24 dB/Octave

### Input/Output Section

Input Section: 2x XLR balanced  
 Output Section: 2x XLR balanced  
 Power Socket: 1x Powercon In + 1x Powercon Out  
 Controls: 1x Input Sensitivity Rotary Switch  
 1x DSP Rotary (Delay 4.5 ms on-board)  
 1x Polarity Inversion Switch (0°, 180°)  
 1x X-Over Frequency Switch (90, 120 Hz)  
 1 x Outputs Mode Switch (Link - X-Over)

### Mechanics

Housing: Multiplex plywood  
 Handles: 3x Per Side  
 Pole Mount: 1x M20 on top  
 Rigging Points: 2x Pick Points on top to fix DRK10/20 rigging frames  
 Width: 515 mm (20.6 in)  
 Height: 640 mm (25.6 in)  
 Depth: 720 mm (28.8 in)  
 Weight: 48 kg (105.82 lbs)

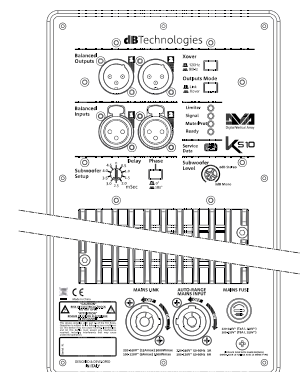



## 2-WAY ACTIVE / *Line Array System*

# DVA MINI G2

Enhancing ease of use as well as versatility thanks to complete network capability, DVA MINI G2 provides stunning power and sound pressure in an extraordinary lightweight and compact enclosure.

### ■ **Full of Technology**



**EXTRA COMPACT LINE ARRAY SYSTEM**

**DUAL PHASE PLUG DESIGN FOR AN EXTREMELY PRECISE DISPERSION**

**COMPLETE NETWORK CAPABILITY VIA AURORA NET**

**131 DB SPL PER MODULE**

**LINEAR PHASE FIR FILTERS**

**FAST AND EASY SET UP WITH INTEGRATED QUICK LOCK SYSTEM**

**EXTRA LIGHTWEIGHT**

**LIGHTWEIGHT NEODYMIUM MAGNETS FOR ALL TRANSDUCERS**





# DVA MINI G2

## Network capability upgrade

Each element is equipped with 2x6.5" neodymium woofers and 2x1" high-frequency neodymium compression drivers and driven by a Class D Digipro G3 amp module providing 400 W RMS. The system can reach an impressive 131-dB-per-unit sound pressure level.

The system's advanced sound processing features linear-phase FIR filters allowing an excellent linear response, resulting in a clear and intelligible audio performance from every listening position.



DVA MINI also features complete network capability via Aurora Net control software which allows EQ, delay and processing customization and real time monitoring of the PA system in use. Nevertheless, the on-board 1 rotary provides for 7 different presets to adapt the system to basic applications.

An integrated quick-lock system links enclosures by simply placing one module below a companion module and sliding it towards one side until it locks in place. The rigging hardware is on the rear of every cabinet allowing for incremental steps for line array positioning. Extra-light DRK M5 flybar easily allows a fast rigging while DSF M2 accessory enables the system to be stacked on a standard pole.

The cabinets are constructed of reinforced polypropylene packing extra power in compact dimensions (460x190x345 mm) and feather-weight (only 8.4 kg per module).



### Technical Data

Speaker Type: 2-Way Active Line Array Module

### Acoustical data

Frequency Response [- 6dB]: 75 - 20.000 Hz  
Usable Bandwidth [- 10dB]: 80 - 19.000 Hz  
Max SPL One Unit: 131 dB  
HF: 2x0.75"  
Type HF: Neodymium  
Voice Coil HF: 1"  
LF: 2x6.5"  
Type LF: Neodymium  
Voice Coil LF: 1.75"  
Horizontal Dispersion: 100°  
Vertical Dispersion: varies on number of modules and configurations

### Amplifier

Amp Technology: Digipro® G3  
Amp Class: Class-D  
RMS Power: 400 W  
Peak Power: 800 W  
Cooling: Convection

### Processor

Controller: DSP 28/56 bit  
AD/DA Converter: 24 bit/48 kHz  
Limiter: Dual Active Peak, RMS, Thermal  
Rotary presets: 1 Rotary BCD 8 positions for line-array configuration (DSP preset)  
Advanced DSP function: Linear Phase FIR filters  
Crossover Frequency LF-HF: 1900 Hz  
Slope LF-HF: 24 dB/Octave

### Input/Output Section

Signal Input: 1x XLR fem. Bal.  
Signal Output: 1x XLR male, Bal.  
Power Supply: 400W SMPS with PSU Auto-range (110V- and 220V-)  
Power Socket: 1x PowerConTRUE1 In, 1x PowerConTRUE1 Out  
Network: RDNet remote control RJ45 connector IN/OUT

### Mechanics

Housing: Polypropylene PP  
Handles: 2x back side  
Fittings: Integrated hardware with fast lock mechanics  
Splay Angles: 0° - 1.5° - 3° - 4.5° - 6° - 8° - 10° - 12.5° - 15°  
Width: 460 mm (18.1 in)  
Height: 190 mm (7.5 in)  
Depth: 345 mm (13.6 in)  
Weight: 8.4 kg (18.5 lbs)

# 2-WAY ACTIVE / *Line Array System*

## M2M+M2S

Offering the same hallmark user-friendliness and sound quality of its DVA siblings, the MINI series sets the new benchmark for easy-to-use systems with top-range sound performance.

The innovative Master + Slave design made for simplified system wiring and scaled down weight, makes this series equally ideal for permanent installation in theatres, houses of worship, convention centres, concert tours and live music performances.

### ■ **Full of Technology**



#### **2-WAY ACTIVE LINE ARRAY SYSTEM**

#### **INTEGRATED HARDWARE WITH FAST LOCK MECHANICS**

#### **LIGHTWEIGHT AND ELEGANT PREMIUM DESIGN**

#### **200+200W RMS DIGIPRO® G3 CLASS-D AMPLIFIER (800W PEAK POWER)**

#### **SWITCHED MODE POWER SUPPLY WITH AUTO-RANGE**

#### **HI-END DIGITAL CONTROLLER ON BOARD (DSP)**

#### **MASTER AND SLAVE CONCEPT**



## DVA M2M

### ■ Technical Data

Speaker Type: 2-Way Active Master Line Array Module

### ■ Acoustical data

Frequency Response [-6dB]: 78 - 19.000 Hz  
Frequency Response [-10dB]: 68 - 20.000 Hz  
Max SPL: One Unit: 126 dB  
HF: 2x1"  
Type HF: Neodymium  
Voice Coil HF: 1"  
LF: 2x6.5"  
Type LF: Neodymium  
Voice Coil LF: 1.5"  
Directivity: 90x15° Single unit

### ■ Amplifier

Amp Technology: Digipro® G3  
Amp Class: Class-D  
RMS Power HF Amp: 200 W (100 W + 100 W)  
RMS Power LF Amp: 200 W (100 W + 100 W)  
Peak Power HF Amp: 400 W (200 W + 200 W)  
Peak Power LF Amp: 400 W (200 W + 200 W)  
Cooling: Convection

### ■ Processor

Controller: DSP 28/56 bit  
AD/DA Converter: 24 bit/48 kHz  
System Presets: 9 presets (8x HF and Low-Mid corrections and 1x for service use)  
Limiter: Multiband, RMS/Peak, Thermal  
Crossover Frequency LF-HF: 1800 Hz  
Slope LF-HF: 24 dB/Octave

### ■ Input/Output Section

Signal Input: 1x XLR fem. Bal.  
Signal Output: 1x XLR male. Bal.  
Power Supply: 400W SMPS with PSU Auto-range (110V- and 220V-)  
Power Socket: 1x PowerCon In + 1x PowerCon Out

### ■ Mechanics

Housing: Polypropylene PP  
Handles: 2x back side  
Fittings: Integrated hardware with fast lock mechanics  
Splay Angles: 0° - 1.5° - 3° - 4.5° - 6° - 8° - 10° - 12.5° - 15°  
Width: 460 mm (18.1 in)  
Height: 190 mm (7.5 in)  
Depth: 345 mm (13.6 in)  
Weight: 7.6 kg (16.8 lbs)

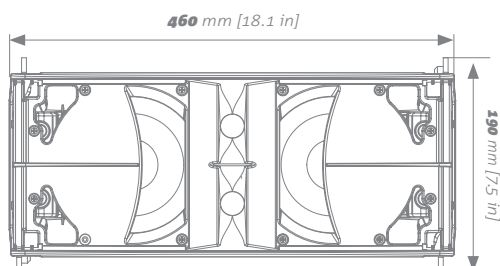

## DVA M2S

### ■ Technical Data

Speaker Type: 2-Way Slave Line Array Module

### ■ Acoustical data

Frequency Response [-6dB]: 78 - 19.000 Hz  
Frequency Response [-10 dB]: 68 - 20.000 Hz  
Max SPL: One Unit: 126 dB  
HF: 2x1"  
Type HF: Neodymium  
Voice Coil HF: 1"  
LF: 2x6.5"  
Type LF: Neodymium  
Voice Coil LF: 1.5"  
Directivity: 90x15° Single unit

### ■ Amplifier

Located on the relative M2M module

### ■ Processor

Located on the relative M2M module

### ■ Input

Signal Input: 1 Custom connector

### ■ Mechanics

Housing: Polypropylene PP  
Handles: 2x back side  
Fittings: Integrated hardware with fast lock mechanics  
Splay Angles: 0° - 1.5° - 3° - 4.5° - 6° - 8° - 10° - 12.5° - 15°  
Width: 460 mm (18.1 in)  
Height: 190 mm (7.5 in)  
Depth: 345 mm (13.6 in)  
Weight: 7.1 kg (15.7 lbs)

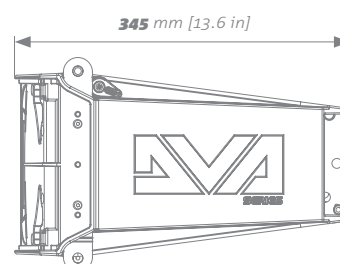

# **Top performance** *Combined with total control*

---



## **Low-mid range constant coverage**

The low and mid-range reproduction is performed by the two 6.5" neodymium woofers, whose disposition and efficiency is extremely optimized thanks to a custom dual phase-plug.

The choice of neodymium magnets ensures even more value to the module, because it contributes to contain the overall weight of the M2M speaker under 7.6 kg/16.8 lbs (7.1 kg/15.7 lbs for the M2S model).



## **Clear and assertive top end**

The two 1" drivers, finely tuned for the DVA M2 custom designed array horns, deliver a crystal clear sound in high frequency, in order to provide the audience with the same intelligibility of the DVA line array systems.



## **Light weight. Heavy duty**

The high quality reinforced Polypropylene enclosure, and the internal hard-wearing anti-vibration structure, makes the M2M and M2S boxes very tough and able to work as heavy duty professional tools.

These features, together with neodymium transducers and the lightweight Digipro amp module, contributes in creating an exceptional weight to power ratio for the lightest among DVA line array systems.

## **Premium design**

DVA Mini is characterized by a very clean aesthetic and a very discreet look.

The integrated rigging mechanics are hidden behind the frontal panel, and the elegant curvature of the frontal hexagonal grille contributes to a very unimpactful design, perfect for any kind of permanent installations or live events.

## **Consistent coverage pattern**

Low and mid-range reproduction has been extremely optimized by a custom dual phase-plug. This technology significantly improves the mid-range efficiency of the speaker and, most of all, makes the horizontal coverage really homogeneous and consistent.



### **Fast lock mechanics**

DVA MINI system allows rapid and simple rigging and installing operations thanks to its peculiar quick-locking system: users just need to place one module below a companion module and slide it until the red lever springs up.

### **Single rear mechanics**

A single mechanic is provided on the back of every single DVA M module. Using incremental angles steps dBTechnologies has greatly improved the precision of the mechanics. Smaller steps between the modules mean more precision in the aiming of your DVA linear array system.



### **Ground stacking options**

Every time it is not possible to fly the system, the DVA mini can serve you as a ground stacked system. Indeed this system can be easily mounted on the top of the MS12 sub without any additional frame or mechanic.

As an optional, DSA-M2 pole mount adapter can handle the line arrays modules, helping the user to elevate the system to a reasonable height through a standard pole.

# ACTIVE BASS REFLEX / *Flyable Subwoofer*

## DVA MS12

DVA MS12 is the flyable subwoofer which comes with the DVA mini series.

Especially designed to fit perfectly with an M2M and M2S array, the MS12 is equipped with a single 12" woofer in a bass reflex enclosure, acting as a perfect low-end extension module for DVA mini systems.

### ■ **Full of Technology**



**ACTIVE BASS REFLEX  
FLYABLE SUBWOOFER**

**INTEGRATED HARDWARE  
WITH INNOVATIVE  
QUICK-LOCK MECHANICS**

**LIGHTWEIGHT AND ELEGANT  
PREMIUM DESIGN**

**700W RMS DIGIPRO® G3  
CLASS-D AMPLIFIER  
(1400W PEAK POWER)**

**SWITCHED MODE POWER  
SUPPLY WITH AUTO-RANGE**

**HI-END DIGITAL CONTROLLER  
ON BOARD (DSP)**

**DUAL FUNCTION FEET  
(FLYING OR GROUND  
STACKING PURPOSES)**



# Top performance

Combined with total control

## DVA MS12

### Versatility

This subwoofer delivers an incredible SPL considering its very compact dimensions, and it can be easily used both flown and ground stacked.

The smart design of the feet allows the user to avoid the dull removal of the flying brackets: it is possible to remove the feet in few seconds and screw them again upside-down. In this way any contact between the flying brackets and the ground is avoided, as only the rubber feet will touch it.

A practical X-over out can be used to feed signal straight to the line arrays modules, simplifying considerably the signal and power cabling.



### Digipro® G3 Class-D amplifier

DVA MS12 comes with the new generation of exclusive digital amplifiers Digipro® G3.

Engineered by dBTechnologies, these new amplifiers deliver a power that you can't expect from such a small amplifier. Distinguished by great new features, an exceptionally lightweight design and a very remarkably efficiency, it pushes the system performance at its maximum.

In order to let the speaker play flawlessly with both 110V- and 220V- power, a Switched Mode Power Supply with auto-range circuit has been built inside the DVA MS12.

### Download telemetry from USB

An integrated USB B-type port on the DVA MS12 amplifier allows the user to access the complete telemetry of the sub, monitoring the status of the speaker, including total playing hours, temperatures and performances reports.

Furthermore it is possible to download a file log as a status report, as well as upgrade the firmware of the DVA MS12 using the same USB port.

### Technical Data

Speaker Type: Active bass reflex flyable subwoofer

### Acoustical data

Frequency Response [-6dB]: 45 - 140 Hz

Frequency Response [-10 dB]: 40 - 165 Hz

Max SPL: One Unit: 131 dB

LF: 12"

Voice Coil LF: 3"

Directivity: Omnidirectional

### Amplifier

Amp Technology: Digipro® G3

Amp Class: Class-D

Power Supply: 700W SMPS with PSU Auto-range (110V- and 220V-)

RMS Power: 700 W

Peak Power: 1400 W

Cooling: Convection

### Processor

Controller: DSP 28/56 bit

AD/DA Converter: 24 bit/48 kHz

Controls: X-Over frequency selection

Phase selection (0° or 180°)

Outputs mode selection (Link/X-over)

Mini-USB "B" type port (service data)

Limiter: Dual active, Multiband, RMS/Peak, Thermal

Crossover Frequency LF-HF: 90Hz - 120Hz

LF X-over out slope: 24 dB/Octave

### Mechanics

Housing: Multiplex plywood - Polyurea painting

Handles: 1x left side, 1x right side

Feet: 4x Dual Position Reversible Feet (flying/stacking mode)

Fittings: M20 screw for pole mount on top side

Integrated hardware with fast lock mechanics

Width: 460 mm (18.1 in)

Height: 430 mm (16.9 in)

Depth: 385 mm (15.2 in)

Weight: 26.5 kg (58.4 lbs)







# AC 26N

## AC 26N

The new audio digital processor AC26N allows you to control any professional audio system, both active and passive.

Equipped with two inputs and six outputs balanced analogically, two in/out digital AES/EBU and an RDNet control, this processor allows a perfect control in a simple and complete way. Each output possesses a parametric equalizer, delay, phase and level control, completely run by a powerful 28/56 Bit DSP, unique in its kind. This processors control may be directed by the front control panel or through an RDNet connected computer.

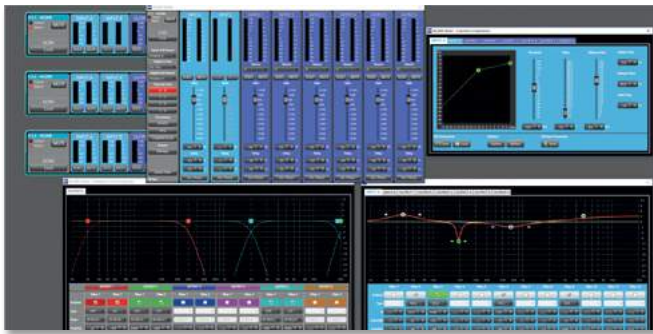

### Technical Data

Digital Audio Controller for Loudspeaker Processing

### I/O

- 2x XLR Balanced analog inputs
- 6x XLR Balanced analog outputs
- 2 channels AES/EBU digital input (XLR connector)
- 2 channels AES/EBU digital outputs (XLR connector)

### General Features

- Full range power supply
- RDNet Hardware Interface
- USB Interface
- Remotable via RDNet or USB with PC software
- Clean and Easy to use user interface on front panel

### Audio Specifications

- Max input level: 21dBu (or 27dBu with -6dB pad)
- Max output level: 21dBu
- DSP processing: 28/56bit - 48KHz
- A/D and D/A Converters: 24bit - 96KHz
- Analog Input S/N ratio: 115dB
- A/D Section S/N ratio: 118dB
- D/A Section S/N ratio: 120dB



## DRK 20M

The DRK20M is the first motorized fly bar in the world for line array systems.

Equipped with a system that modifies the clusters focal point, it is possible to adjust the inclination of the sound system in any moment without having to lower the loudspeakers; this makes it possible to change the sound coverage, when necessary, even during the event.

This system can be directed from RDNet or by simply using a manual remote control connected with a standard XLR cable.

### Motorized Rigging Frame

The DRK 20M is equipped with an RDNet interface, in order to control each of its functions through a computer and monitor its position in real time. The motorized flybar is also very useful in facilitating the installation of line array modules by adjusting the clusters inclination progressively, as each single modules' applied angles vary. Thanks to its solid structure in special steel, it is possible to hang speakers of the DVA series with a weight of up to 1000 kg, TUV certified.

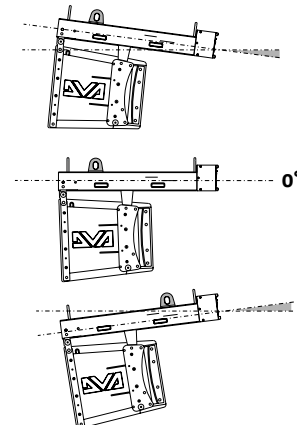

# DVA Accessories

## Bags/Covers

	<b>Description</b>	<b>Designed for</b>
<b>DRP S15</b>	Rain cover for DVA S1518 N – S1521 N – S2585 N	DVA S1518 N / DVA S1521 N / DVA S2585 N
<b>DRP S30</b>	Rain cover DVA S30 N and DVA KS20	DVA S30 N / DVA KS20
<b>RC M2</b>	Rain cover for DVA Mini G2, M2M, M2S and M2P	DVA Mini G2, M2M+M2S / DVA M2P
<b>RC MS12-SUBH</b>	Rain cover for DVA MS12 and DVA KS10	DVA MS12 / DVA KS10
<b>TC 08S</b>	Transport cover for DVA S08 DP	DVA S08 DP
<b>TC 09S</b>	Transport cover for DVA S09 DP	DVA S09 DP
<b>TC 10S</b>	Transport cover for DVA S1518 N	DVA S1518 N
<b>TC 20S/TC 30S</b>	Transport cover for DVA S30 N and DVA KS20	DVA S30 N / DVA KS20

## Cables

	<b>Description</b>	<b>Designed for</b>
<b>AFL 05</b>	Powercon-Powercon link cable. 1.5m length. Used to Link: DVA T8 - T12 - K5 to DVA SUBS (S1518N - S1521N - S2585N - S09DP - S08DP - KS20 - KS10)	DVA T8 / DVA T12/ DVA K5 / DVA S08 DP / DVA S09 DP / DVA S1518 N / DVA S1521 N / DVA S2585 N / DVA KS10 / DVA KS20
<b>CAT6-CAT6-500</b>	CAT6-CAT6 link cable (500cm) for DANTETM AoIP and RDNet. EtherCON connectors.	DVA S08 DP / DVA S09 DP / DVA S1518 N / DVA S1521 N / DVA S2585 N / DVA KS10 / DVA KS20 / DVA S30 / DVA MS12
<b>DAC 15</b>	XLR-XLR audio cable (50 cm)	DVA T8 / DVA K5 / DVA MS12 / DVA M2M / DVA MINI G2
<b>DAC 500</b>	XLR-XLR audio cable (500 cm)	DVA S08 DP / DVA S09 DP / DVA S1518 N / DVA S1521 N / DVA S2585 N / DVA KS10 / DVA KS20 / DVA S30 / DVA MS12
<b>DCK 15</b>	Cable-Set containing one Powercon-Powercon Patch Cable (50cm) and one XLR-XLR Patch Cable (50cm)	DVA M2M / DVA MS12 / DVA T8 / DVA K5 / DVA MINI G2
<b>DCK 27</b>	Cable-Set containing 2x Powercon links. 70cm blue/grey, 2 x XLR M/F 70 cm	DVA T12
<b>DCK 45</b>	Cable-Set including 1x Powercon / IEC Plug cable (10m), 3x Powercon Slave (50cm) and 3x XLR Patch Cable (50cm)	DVA M2M / DVA T8 / DVA T12 / DVA K5 / DVA MINI G2
<b>DPC 1000M</b>	Mains Powercon cable (10m)	DVA Speakers & Subs
<b>DPC 15</b>	Powercon-Powercon power link cable (50cm)	DVA M2M / DVA MS12 / DVA T8 / DVA K5 / DVA MINI G2
<b>RDC-45F</b>	RJ45 to XLR 3 poles female conversion cable. 6 cm length. The cable converts from DRNet RJ45 to XLRF	DVA RDNet Speakers & Subs
<b>RDC-45M</b>	RJ45 to XLR 3 poles male conversion cable. 6 cm length. The cable converts from DRNet RJ45 to XLRM	DVA RDNet Speakers & Subs
<b>RJ45-RJ45-150</b>	RJ45-RJ45 link cable (150cm) for RDNet-equipped speakers. Professional cable with double shielding and Neutrik connectors	DVA RDNet Speakers & Subs
<b>RJ45-RJ45-75</b>	RJ45-RJ45 link cable (75cm) for RDNet-equipped speakers. Professional cable with double shielding and Neutrik connectors	DVA RDNet Speakers & Subs

# Electronics

## RDNet Control 2

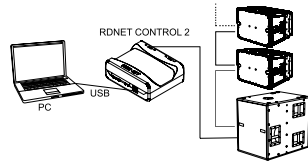

### Description

RDNet Controller for 2 Lines to control up to 32 Speakers. USB interface

### Designed for

DVA RDNet Speakers & Subs

## RDNet Control 8

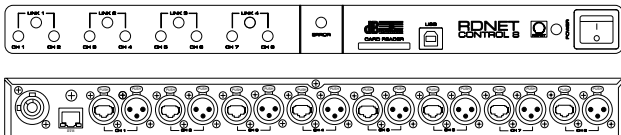

### Description

RDNet Controller for 8 Lines to control up to 256 Speakers. USB and Ethernet interface

### Designed for

DVA RDNet Speakers & Subs

# Transport

## ADTF-2

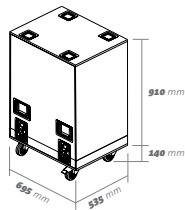

### Description

Flight case for 2 DVA T12 modules. The case is equipped with self-centering metal cart to facilitate assembly and disassembly of the modules

### Designed for

DVA T12. Compatible with DVA T8 and T4, DVA K5

## ADTF-3

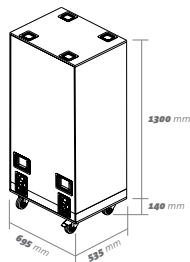

### Description

Flight case for 3 DVA T12 modules. The case is equipped with self-centering metal cart to facilitate assembly and disassembly of the modules

### Designed for

DVA T12. Compatible with DVA T8 and T4, DVA K5

## DF 4

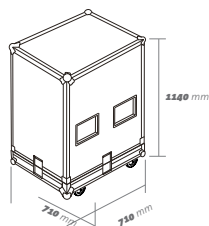

### Description

Fly case for DVA T4 and T8 modules in black laminated wood veneer with aluminium profiles. It does not include the DT-6 trolley (Optional)

### Designed for

DVA T4 / DVA T8 / DVA K5

## DVA Accessories

### DO 18

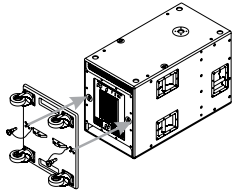

#### Description

Dolly for S1518, S2585 (including wheels)

#### Designed for

DVA S1518 N / DVA S2585 N

### DO 218

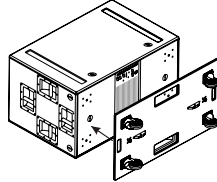

#### Description

Dolly for DVA S30 (including wheels)

#### Designed for

DVA S30 N

### DT 6

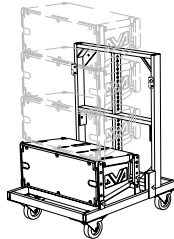

#### Description

Metal trolley to carry up to 6 DVA T4/T8 modules or up to 4 DVA T12 modules. In case of T4/T8 modules, when combined with DF-4 flight case, you can also fit 1 DRK-10 fly bar and various cables in the rear. Ready for mounting 4 Blue-wheels (included)

#### Designed for

DVA T12 / DVA T4 / DVA T8 / DVA K5

### DT-8MINI



#### Description

Metal trolley for DVA Mini systems

#### Designed for

DVA M2M+M2S / DVA MS12 / DVA M2P / DVA MINI G2

### DTF 4

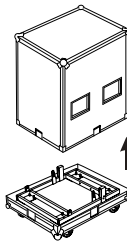

#### Description

Bundle: DT 6 Metal-Trolley + Professional flight case DF 4 to setup, disassemble and transport DVA T4 - T8 modules. You can also fit 1 DRK-10 fly bar and various cables in the rear

#### Designed for

DVA T4 / DVA T8 / DVA K5

### DWK 20



#### Description

Kit consisting of 4-wheel for DVA subwoofers

#### Designed for

DVA S09 DP / DVA S1518 N / DVA S2585 N

### SWK-18 KIT



#### Description

Kit consisting of 4 wheels for DVA K subwoofers back panel

#### Designed for

DVA KS10 / DVA KS20 / DVA S1521 N / DVA S30 N

# Installation

## DGS MS12

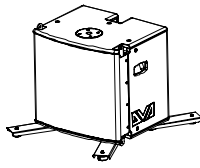

### Description

Base for ground stacking DVA MS12 and DVA M2

### Designed for

DVA MS12

## DRK-10 & DRK-10W

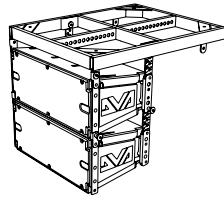

### Description

Flybar for all DVA systems. Designed to hang up to a maximum weight of 250 Kg (TUV certified). Usable for stack configurations with supplied hardware, either on DVA subwoofers or on the stage directly. White available

### Designed for

DVA S09 DP / DVA S1518 N / DVA 1521 N / DVA S2585 N / DVA S30 N / DVA T12 / DVA T8 / DVA K5 / DVA KS10 / DVA KS20

## DRK-20

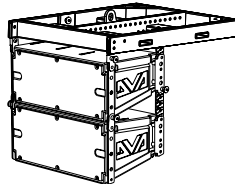

### Description

Flybar for DVA systems. Designed to hang up to a max. weight of 1800 kg (TUV certified). Usable for stack configurations with supplied hardware, either on DVA subwoofers or on the stage directly.

### Designed for

DVA S09 DP / DVA S1518 N / DVA 1521 N / DVA S2585 N / DVA S30 N / DVA T12 / DVA T8 / DVA K5 / DVA KS10 / DVA KS20

## DRK-M5 & DRK-M5W



### Description

Fly bar for hanging up to 400 Kg. White available

### Designed for

DVA MINI G2 / DVA M2M+M2S / DVA M2P / DVA MS12

## DRK-HK



### Description

Additional hook for DRK-20, plus 2 Pins

### Designed for

DVA S09 DP / DVA S1518 N / DVA 1521 N / DVA S2585 N / DVA S30 N / DVA T12 / DVA T8 / DVA K5 / DVA KS10 / DVA KS20

## DS-2



### Description

Pole Mount 35mm, adjustable, M20 thread.

### Designed for

DVA S08 DP / DVA S09 DP / DVA S30 N / DVA S1518 N / DVA S2585 N / DVA S1521 N / DVA T8 / DVA K5 / DVA KS10 / DVA KS20 / DVA MINI G2 / DVA M2M+M2S / DVA M2P / DVA MS12

## DS2-S

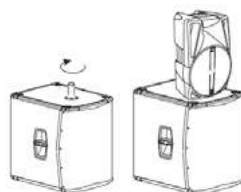

### Description

Pole Mount M20 thread, 11cm length. It can be used on all DVA subs. It allows the installation of any loudspeakers provided with a 35 mm hole on any subwoofer with threaded M20 speaker stacking.

### Designed for

DVA S08 DP / DVA S09 DP / DVA S30 N / DVA MS12 / DVA S1518 N / DVA S2585 N / DVA S1521 N / DVA KS10 / DVA KS20

# DVA Accessories

## DSA-4

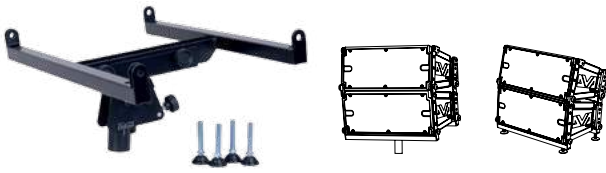

### Description

Adapter for up to 3 DVA T8/K5 on a speaker stand/pole or floor use through adjustable feet. Throw angle adjustable through graduated knob

### Designed for

DVA T8 / DVA K5

## DSA-M2A



### Description

Pole mount adapter for DVA Mini modules (maximum 3 DVA MINI G2 or 2 couple of DVA M2M+M2S)

### Designed for

DVA MINI G2 / DVA M2M+M2S / DVA M2P

## DSF-M2

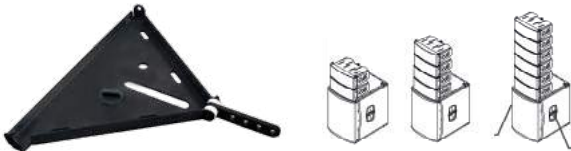

### Description

Adapter for fixing DVA M2 or DVA MINI G2 to SUBs.

### Designed for

DVA MINI G2 / DVA M2M+DVA M2S / DVA M2P

## DWB-3

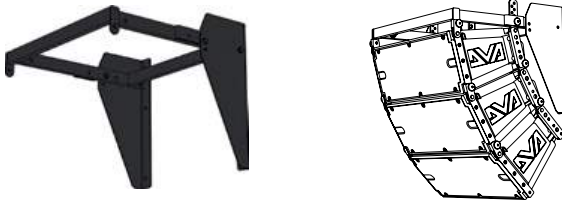

### Description

Metal frame for hanging up to 3 DVA T8 / K5 modules in fixed installations on walls.

### Designed for

DVA T8 / DVA K5 / DVA KS10

## SRK-09 & SRK-09W

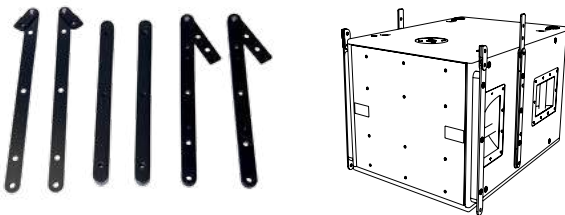

### Description

Optional hardware kit to hang up DVA S09 DP to DRK-10 or DRK-20 flybars. It allows you to hang up other DVA T line arrays under subs or can be used to create stack configurations without any fly bar. White available

### Designed for

DVA S09 DP

## SRK-10 & SRK-10W

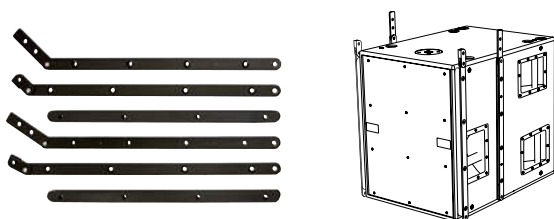

### Description

Optional hardware kit to hang up DVA KS10, S1518 N and S2585 N subs to DRK-10 or DRK-20 flybars. It allows you to hang up other DVA T line arrays under subs or can be used to create stack configurations without any fly bar. White available

### Designed for

DVA S1518 N / DVA S2585 N / DVA KS10



# DIGITAL ACTIVE SYSTEMS

DVX **D8 HP**  
DVX **D10 HP**  
DVX **D12 HP**  
DVX **D15 HP**  
DVX **DM12 TH**  
DVX **DM15 TH**  
DVX **DM28**  
DVX **DM12**  
DVX **DM15**

- ✦ **VERSATILE AND ROBUST**
- ✦ **DVX MULTIFUNCTIONAL SYSTEMS**
- ✦ **HIGH-QUALITY SPEAKER COMPONENTS**
- ✦ **ENTIRE ACTIVE SYSTEM DESIGN EASD**

The DVX series combines dBTechnologies digipro®G2 power amp technology and state-of-the-art transducers to raise the bar several notches for sound pressure, performance, and response.

Boasting an impressive feature set comprising high quality input board, multifunctional multiplex housings equipped with rigging points and rails, flexible configuration options, and an unrivalled price-to-performance ratio, DVX systems are discerning professionals' go-to solutions for a vast range of applications.

Alongside the four multifunctional

two-way systems, the DVX line also comprises the three DM28, DM12, and DM15 low-profile stage monitors. All models feature high-quality loudspeaker chassis. Innovative, high-performance dBTechnologies digipro®G2 power amps deliver impressive 900W each to drive these advanced speakers.

Specially designed, rotatable high-frequency horns provide very clean and constant directivity. All high-frequency horns are made of aluminum to help keep their drivers cool.

The integrated DSP carries out various tasks involved in controlling

digipro®G2 power amps, serving as active equalizer, x-over, high-pass filter, as well as performing audio setup tasks, aligning phases and delay time, and controlling the limiter to ensure utmost reliability and operating safety.

All DVX Series models come in a professional-grade multiplex housing equipped with PowerCon mains connectors and a rugged metal grille backed with laminated acoustic foam rubber. D12 HP and D15 HP models feature high-quality aluminum grips, a pole mount, and a rigging system. DM12 and DM15 monitors are also equipped with a pole mount.

# PROFESSIONAL / *Active Speakers*

## ▶ DVX D8 HP

### ■ **Technical Data**

Speaker Type: 2-Way Active Speaker

### ■ **Acoustical data**

Frequency Response [- 10dB]: 75 - 20.000 Hz

Frequency Response [- 3dB]: 100 - 19.000 Hz

Max SPL: 125 dB

HF: 1"

Voice Coil HF: Titanium 1.7"

Directivity: 90x70°

Horn: CD Horn Aluminium

Rotatable Horn: YES

LF: 8"

Voice Coil LF: 2"

### ■ **Amplifier**

Amp Technology: Digipro® G2

Amp Class: Class-D

RMS Power: 400 W

Peak Power: 800 W

### ■ **Processor**

Controller: DSP 24 Bit/48 kHz

System Presets: Flat, Monitor

Limiter: RMS, Peak, Thermal, Multiband

Crossover Frequency MF-HF: 1800 Hz

### ■ **Mechanics**

Housing: Multiplex plywood

Housing Design: Multifunctional

Angles Up: Monitor use 45°

Rigging Points: 6x M8 2x 10mm Quick Release  
for DTF-bracket

Width: 250 mm (10 in)

Height: 425 mm (17 in)

Depth: 260 mm (10.4 in)

Weight: 9.7 kg (21.38 lbs)

## ▶ DVX D10 HP

### ■ **Technical Data**

Speaker Type: 2-Way Active Speaker

### ■ **Acoustical data**

Frequency Response [- 10dB]: 70 - 20.000 Hz

Frequency Response [- 3dB]: 85 - 19.000 Hz

Max SPL: 127 dB

HF: 1"

Voice Coil HF: Titanium 1.7"

Directivity: 90x70°

Horn: CD Horn Aluminium

Rotatable Horn: YES

LF: 10"

Voice Coil LF: 2.5"

### ■ **Amplifier**

Amp Technology: Digipro® G2

Amp Class: Class-D

RMS Power: 600 W

Peak Power: 1200 W

### ■ **Processor**

Controller: DSP 24 Bit/48 kHz

System Presets: Flat, Monitor

Limiter: RMS, Peak, Thermal, Multiband

Crossover Frequency MF-HF: 1600 Hz

### ■ **Mechanics**

Housing: Multiplex plywood

Housing Design: Multifunctional

Angles Up: Monitor use 45°

Rigging Points: 6x M8 2x 10mm Quick Release  
for DTF-bracket

Flytracks: 3x on top 3x on bottom

Width: 290 mm (11.6 in)

Height: 510 mm (20.4 in)

Depth: 310 mm (12.4 in)

Weight: 15.8 kg (34.83 lbs)





## DVX D12 HP

### ■ **Technical Data**

Speaker Type: 2-Way Active Speaker

### ■ **Acoustical data**

Frequency Response [- 10dB]: 55 - 20.000 Hz

Frequency Response [- 3dB]: 68 - 19.000 Hz

Max SPL: 131 dB

HF: 1.4"

Voice Coil HF: 2.5"

Directivity: 60x40°

Horn: CD Horn Aluminium

Rotatable Horn: YES

LF: 12"

Voice Coil LF: 3"

### ■ **Amplifier**

Amp Technology: Digipro® G2

Amp Class: Class-D

RMS Power: 700 W

Peak Power: 1400 W

### ■ **Processor**

Controller: DSP 24 Bit/48 kHz

System Presets: Flat, Monitor

Limiter: RMS, Peak, Thermal, Multiband

Crossover Frequency MF-HF: 1350 Hz

### ■ **Mechanics**

Housing: Multiplex plywood

Housing Design: Multifunctional

Angles Up: Monitor use 45°

Rigging Points: 6x M10 4x Quick-Release Pins

Flytracks: 3x on top 3x on bottom

Width: 370 mm (14.8 in)

Height: 625 mm (25 in)

Depth: 395 mm (15.8 in)

Weight: 27.5 kg (60.63 lbs)



## DVX D15 HP

### ■ **Technical Data**

Speaker Type: 2-Way Active Speaker

### ■ **Acoustical data**

Frequency Response [- 10dB]: 49 - 20.000 Hz

Frequency Response [- 3dB]: 57 - 19.000 Hz

Max SPL: 132 dB

HF: 1.4"

Voice Coil HF: Titanium 2.5"

Directivity: 60x40°

Horn: CD Horn Aluminium

Rotatable Horn: YES

LF: 15"

Voice Coil LF: 3.5"

### ■ **Amplifier**

Amp Technology: Digipro® G2

Amp Class: Class-D

RMS Power: 700 W

Peak Power: 1400 W

### ■ **Processor**

Controller: DSP 24 Bit/48 kHz

System Presets: Flat, Monitor

Limiter: RMS, Peak, Thermal, Multiband

Crossover Frequency MF-HF: 1320 Hz

### ■ **Mechanics**

Housing: Multiplex plywood

Housing Design: Multifunctional

Angles Up: Monitor use 45°

Rigging Points: 6x M10 4x Quick-Release Pins

Flytracks: 3x on top 3x on bottom

Width: 430 mm (17.2 in)

Height: 690 mm (27.6 in)

Depth: 450 mm (18 in)

Weight: 30.3 kg (66.8 lbs)



# PROFESSIONAL / Stage Monitors

## DM12 TH DM15 TH

DVX DM TH: it's not just an upgrade of the well-known series DVX DM digital monitors, it is rather a brand new line. These products are exclusively aimed to fulfill the requirements of musicians and stage engineers.

The DVX TH series is equipped with neodymium heavy-duty woofers, 12" or 15", with 4" voice coil. Besides it features top-class neodymium compression drivers, 1500W RMS Digipro™ amplifiers and Switched Mode Power Supply with PFC. These features provide the musicians with an excellent listening, even on the most demanding and loud stages. DVX TH ensures a sound quality and intelligibility without compromise.

The models DVX DM12 TH and DM15 TH can reach elevate SPL levels, maintaining both a linear response and an impressive punch. At the same time it will keep unaltered the DVX DM's typical dimensions and versatility.

### ■ Full of Technology



**1500W RMS DIGIPRO™  
CLASS-D AMPLIFIERS**

**STATE-OF-THE-ART  
NEODYMIUM TRANSDUCERS**

**ROTATABLE FRONTAL PANEL  
(LEFT-RIGHT CONFIGURATION)**

**DOUBLE EQ PRESET  
ON-BOARD**

**INPUT AND OUTPUT PANELS  
ON BOTH SIDES**

**SMPS WITH ACTIVE PFC  
(FROM 100V~ TO 240V~)**



## DVX D12 TH

### ■ Technical Data

Speaker Type: 2-way Active Stage Monitor

### ■ Acoustical data

Frequency Response [- 6dB]: 63 - 16.000 Hz  
Frequency Response [- 10dB]: 59 - 18.000 Hz  
Max SPL: 136 dB  
HF: 1.4"  
Type HF: Neodymium  
Voice Coil HF: 2.5"  
Horn: Aluminum rotatable horn  
LF: 12"  
Type LF: Neodymium  
Voice Coil LF: 4"  
Directivity: 40x90°

### ■ Amplifier

Amp Technology: Digipro® G2  
Amp Class: Class-D  
RMS Power: 1500 W  
Peak Power: 3000 W  
LF: 750 W RMS @4 Ohm  
HF: 375 W RMS @8 Ohm  
Cooling: Single fan

### ■ Processor

Controller: DSP 56 bit  
AD/DA Converter: 24 bit/48 kHz  
System Presets: Flat EQ, TH EQ  
Limiter: Dual active, Multiband, RMS/Peak, Thermal  
Crossover Frequency LF-HF: 1070 Hz  
Slope LF-HF: 24 dB/Octave

### ■ Mechanics

Housing: Multiplex plywood - Polyurea painting  
Advanced features: Rotatable front panel (left or right monitor customization)  
Angles Up: 35°, 55°  
Handles: 1x left side, 1x right side  
Width: 670 mm (26.4 in)  
Height: 325 mm (12.8 in)  
Depth: 405 mm (15.9 in)  
Weight: 24.5 kg (54 lbs)



## DVX D15 TH

### ■ Technical Data

Speaker Type: 2-way Active Stage Monitor

### ■ Acoustical data

Frequency Response [- 6dB]: 55 - 16.000 Hz  
Frequency Response [- 10dB]: 47 - 18.000 Hz  
Max SPL: 136 dB  
HF: 1.4"  
Type HF: Neodymium  
Voice Coil HF: 2.5"  
Horn: Aluminum rotatable horn  
LF: 15"  
Type LF: Neodymium  
Voice Coil LF: 4"  
Directivity: 40x90°

### ■ Amplifier

Amp Technology: Digipro® G2  
Amp Class: Class-D  
RMS Power: 1500 W  
Peak Power: 3000 W  
LF: 750 W RMS @4 Ohm  
HF: 375 W RMS @8 Ohm  
Cooling: Single fan

### ■ Processor

Controller: DSP 56 bit  
AD/DA Converter: 24 bit/48 kHz  
System Presets: Flat EQ, TH EQ  
Limiter: Dual active, Multiband, RMS/Peak, Thermal  
Crossover Frequency LF-HF: 1070 Hz  
Slope LF-HF: 24 dB/Octave

### ■ Mechanics

Housing: Multiplex plywood - Polyurea painting  
Advanced features: Rotatable front panel (left or right monitor customization)  
Angles Up: 35°, 55°  
Handles: 1x left side, 1x right side  
Width: 735 mm (28.9 in)  
Height: 355 mm (14 in)  
Depth: 447 mm (17.6 in)  
Weight: 28.5 kg (62.8 lbs)



# Power. Unleashed.



## An incredible output

A masterpiece of power, quality and Italian design. The DVX DM TH's monitors are the outcome of the collaboration between some of the most important touring professionals and dBTechnologies R&D staff. As a result of this synergy, these products feature acoustic responses and performances that suit the most prestigious stages of the international scene.

Thanks to an incredibly high SPL, considering its dimensions, the TH is suitable for every circumstance; besides, its frequency response can be regulated through two preset equalizations: Flat EQ and TH EQ.

The DM12 TH and DM15 TH monitors feature the phase plug technology, providing a correction of the phase and frequency response of the 12" (or 15") woofer. The results are a coherent horizontal coverage and a great definition of the mid-frequencies.

The stage monitors have a multiplex plywood, painted with polyurea, in order to guarantee excellent touring-proof resistance and durability.



## Left or right in a flash

The DVX DM TH offers a unique feature that is functional to meet the requirements of the most exigent professionals. In few minutes, you can regulate the monitor's orientation, rotating the whole frontal panel. The internal geometry of the speaker will be so inverted, moving the horn from the left side to right side, or vice versa. It is now possible to consistently couple two adjacent monitor HF horns and avoid comb filters.

You will be able to discern if a monitor is in a right or left configuration in every moment. Despite the grid has been remounted, a logo will indicate the internal disposition of the transducers.

For a vertical usage (like a drumfill system), it is also possible to rotate the monitor's CD aluminum horn, in order to optimize the speaker's dispersion and adapting it to the new configuration.



## Hidden handles and floor coupling

The innovative positioning of the connectors panels makes the wiring even more intuitive. Having the inputs (PowerCon and XLR) on one side and the links on the other one (PowerCon and XLR), the stage will be orderly, without any cable visible.

Besides, this disposition enables the positioning of the adjacent monitors, without any space between the two boxes. As a result, the coupling effect - as well as the stage look - will be optimized.





## Stage Monitor

Unlike conventional multifunctional speakers, the DVX DM is a prograde performer developed specifically for use as a floor monitor.

Optimized to resist feedback even at extremely high levels, it delivers the true-to-nature response and dynamic balance that today's artists demand.

The integrated digipro® digital power amps deliver the requisite output. The switched mode power supplies with PFC ensure touring rigs get all the juice they need to perform at their peak even when a venue's mains power is weak and voltage is low.

The on-board controller encompasses an active equalizer, active x-over including phase and time alignment, limiters, and switchable system presets that adapt the monitor's performance to suit the given application. Made of rugged multiplex and coated with tough black lacquer, the cabinet sets up at two different angles.

Specially designed, rotatable high-frequency horns provide very clean and constant directivity. By rotating the horn, the directivity of high frequencies can be adjusted, no matter if the cabinet is mounted horizontally or vertically.

A great and professional feature for fixed install purposes or when a multifunctional speaker is used as stage monitor.

# DVX DM28

## ■ Technical Data

Speaker Type: 2-Way Active Stage Monitor

## ■ Acoustical data

Frequency Response [- 10dB]: 60 - 20.000 Hz

Frequency Response [- 3dB]: 70 - 19.000 Hz

Max SPL: 130 dB

HF: 1"

Type HF: Neodymium Compression Driver

Voice Coil HF: Titanium 1.75"

Directivity: 60/40x90°

Horn: Asymmetrical

LF: 2x8"

Type LF: Neodymium

Voice Coil LF: 2.5"

## ■ Amplifier

Amp Technology: Digipro®

Amp Class: Class-D

RMS Power: 750 W

Peak Power: 1500 W

Cooling: Convection

## ■ Processor

Controller: DSP 24 Bit/48 kHz

System Presets: Flat, Monitor

Limiter: RMS, Peak, Thermal, Multiband

Crossover Frequency MF-HF: 1600 Hz

Slope MF-HF: 24 dB/Octave

## ■ Mechanics

Housing: Multiplex plywood

Housing Design: Low Profile Multifunctional

Angles Up: 30°, 60°

Width: 480 mm (19.2 in)

Height: 265 mm (10.6 in)

Depth: 418 mm (16.72 in)

Weight: 14 kg (30.86 lbs)



## DVX DM12

### ■ Technical Data

Speaker Type: 2-Way Active Stage Monitor

### ■ Acoustical data

Frequency Response [- 10dB]: 55 - 20.000 Hz

Frequency Response [- 3dB]: 68 - 19.000 Hz

Max SPL: 131 dB

HF: 1.4"

Type HF: Neodymium Compression Driver

Voice Coil HF: Titanium 2.5"

Directivity: 40x90°

Horn: CD Horn Aluminium

Rotatable Horn: YES

LF: 12"

Type LF: Neodymium

Voice Coil LF: 3"

### ■ Amplifier

Amp Technology: Digipro®

Amp Class: Class-D

RMS Power: 750 W

Peak Power: 1500 W

Cooling: Convection

### ■ Processor

Controller: DSP 24 Bit/48 kHz

System Presets: Flat, Monitor

Limiter: RMS, Peak, Thermal, Multiband

Crossover Frequency MF-HF: 1350 Hz

Slope MF-HF: 24 dB/Octave

### ■ Mechanics

Housing: Multiplex plywood

Housing Design: Low Profile Multifunctional

Angles Up: 35°, 55°

Rigging Points: 6x M10 4x Quick-Release Pins

Width: 660 mm (14.8 in)

Height: 305 mm (25 in)

Depth: 378 mm (15.8 in)

Weight: 17.5 kg (55.12 lbs)



## DVX DM15

### ■ Technical Data

Speaker Type: 2-Way Active Stage Monitor

### ■ Acoustical data

Frequency Response [- 10dB]: 50 - 20.000 Hz

Frequency Response [- 3dB]: 59 - 19.000 Hz

Max SPL: 132 dB

HF: 1.4"

Type HF: Neodymium Compression Driver

Voice Coil HF: Titanium 2.5"

Directivity: 40x60°

Horn: CD Horn Aluminium

Rotatable Horn: YES

LF: 15"

Type LF: Neodymium

Voice Coil LF: 3.5"

### ■ Amplifier

Amp Technology: Digipro®

Amp Class: Class-D

RMS Power: 750 W

Peak Power: 1500 W

Cooling: Convection

### ■ Processor

Controller: DSP 24 Bit/48 kHz

System Presets: Flat, Monitor

Limiter: RMS, Peak, Thermal, Multiband

Crossover Frequency MF-HF: 1320 Hz

Slope MF-HF: 24 dB/Octave

### ■ Mechanics

Housing: Multiplex plywood

Housing Design: Low Profile Multifunctional

Angles Up: 35°, 55°

Rigging Points: 6x M8

Width: 734 mm (29.36 in)

Height: 338 mm (13.52 in)

Depth: 442 mm (17.68 in)

Weight: 21 kg (46.3 lbs)



## Bags/Covers

	<b>Description</b>	<b>Designed for</b>
<b>TC 8</b>	Transport cover for DVX 8" speakers	DVX D8 HP / DVX P8
<b>TC 10</b>	Transport cover for DVX 10" speakers	DVX D10 HP / DVX P10
<b>TC 12</b>	Transport cover for DVX 12" speakers	DVX D12 HP / DVX P12
<b>TC 15</b>	Transport cover for DVX 15" speakers	DVX D15HP / DVX P15
<b>TC 12M</b>	Transport Cover for DVX DM12	DVX DM 12
<b>TC 15M</b>	Transport Cover for DVX DM15	DVX DM15
<b>TC 28M</b>	Transport Cover for DVX DM28	DVX DM 28

## Installation

### DTF 8

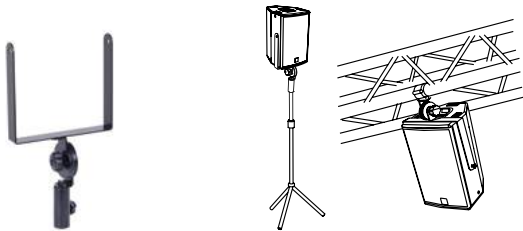

#### Description

Easy mount bracket for DVX 8" speakers. It includes 2 quick release pins. Vertical angle adjustable through gear knob. Pole mount adapter included.

#### Designed for

DVX D8 HP / DVX P8

### DTF 8A



#### Description

Easy mount bracket for DVX 8" speakers. It can be mounted either on the wall or on any kind of structure. The speaker is attached to the bracket using 2 pins that allow its quick disassembly without changing the installation position. The gear knob can be locked at any angle. Black color

#### Designed for

DVX D8 HP / DVX P8

### DTF 10

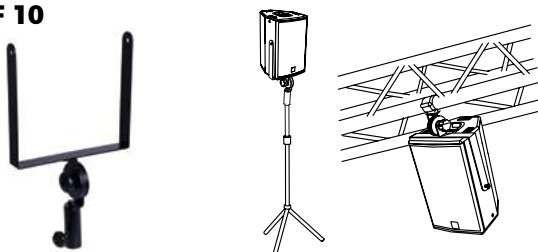

#### Description

Easy mount bracket for DVX 10" speakers. It includes 2 quick release pins. Vertical angle adjustable through gear knob. Pole mount adapter included.

#### Designed for

DVX D10 HP / DVX P10

### DTF 10A



#### Description

Bracket for DVX 10" speakers. It can be mounted either on the wall or on any kind of structure. The speaker is attached to the bracket using 2 pins that allow its quick disassembly without changing the installation position. The gear knob can be locked at any angle.

#### Designed for

DVX D10 HP / DVX P10

# Installation

## DTF 12

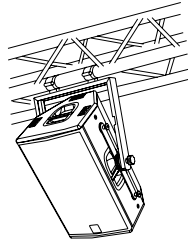

### Description

Easy mount bracket for DVX 12" speakers. It includes 2 quick release pins. Vertical angle adjustable through gear knob. Pole mount adapter included.

### Designed for

DVX D12 HP / DVX P12

## DTF 15

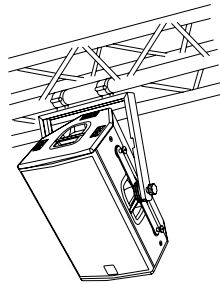

### Description

Easy mount bracket for DVX 15" speakers. It includes 2 quick release pins. Vertical angle adjustable through gear knob. Pole mount adapter included.

### Designed for

DVX D15 HP / DVX P15

## TE M8

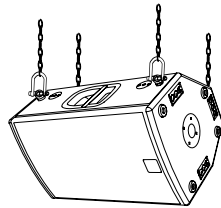

### Description

Eye-bolt set (4 pcs) with M8-thread

### Designed for

DVX D10 HP / DVX D8 HP / DVX P8 / DVX P10

## TE M10

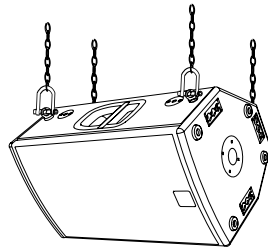

### Description

Eye-bolt set (4 pcs) with M10-thread

### Designed for

DVX D12 HP / DVX D15 HP / DVX / DM 12 / DVX P10 / DVX P12 / DVX P215

## WB09



### Description

Universal wall mount bracket. swivel and tilt Ø35mm pole mount

### Designed for

DVX HP Series / DVX P8 / DVX P10 / DVX P12 / DVXP15



Find all products datasheets on  
**[www.dbtechnologies.com](http://www.dbtechnologies.com)**

Features, specification and appearance of products are subject to change without notice. dBTechnologies reserves the right to make changes or improvements in design or manufacturing without assuming any obligation to change or improve products previously manufactured.

**dBTechnologies**

Italy & International sales

**AEB Industriale Srl**

Via Brodolini, 8 - Loc. Crespellano  
40053 Valsamoggia (BO) ITALY  
Tel. +39 051 96 98 70  
Fax. +39 051 96 97 25

[info@dbtechnologies-aeb.com](mailto:info@dbtechnologies-aeb.com)

**dBTechnologies Deutschland GmbH**

Germany, Belgium, Netherlands, Luxembourg, Austria

Hansestrasse 93

51149 Köln

Tel. +49 (0)2203 925370

Fax. +49 (0)2203 9253773

[verkauf@dbtechnologies.de](mailto:verkauf@dbtechnologies.de)



**dBTechnologies**

[www.dbtechnologies.com](http://www.dbtechnologies.com)